

WESTERN



AUSTRALIA

TITLE NUMBER

Volume

2510

Folio

203

RECORD OF CERTIFICATE OF TITLE
UNDER THE TRANSFER OF LAND ACT 1893 AND THE
STRATA TITLES ACT OF 1985

The person described in the first schedule is the registered proprietor of an estate in fee simple in the land described below subject to the reservations, conditions and depth limit contained in the original grant (if a grant issued) and to the limitations, interests, encumbrances and notifications shown in the second schedule.

BG Roberts
REGISTRAR OF TITLES



LAND DESCRIPTION:

LOT 19 ON STRATA PLAN 37612

TOGETHER WITH A SHARE IN COMMON PROPERTY (IF ANY) AS SET OUT ON THE STRATA PLAN

REGISTERED PROPRIETOR:
(FIRST SCHEDULE)

(T L345460) REGISTERED 15/6/2010

LIMITATIONS, INTERESTS, ENCUMBRANCES AND NOTIFICATIONS:
(SECOND SCHEDULE)

- INTERESTS NOTIFIED ON THE STRATA PLAN AND ANY AMENDMENTS TO LOTS OR COMMON PROPERTY NOTIFIED THEREON BY VIRTUE OF THE PROVISIONS OF THE STRATA TITLES ACT OF 1985 AS AMENDED.
- O168259** MEMORIAL. HERITAGE OF WESTERN AUSTRALIA ACT 1990. LODGED 10/6/2019.

Warning: A current search of the sketch of the land should be obtained where detail of position, dimensions or area of the lot is required.

-----END OF CERTIFICATE OF TITLE-----

STATEMENTS:

The statements set out below are not intended to be nor should they be relied on as substitutes for inspection of the land and the relevant documents or for local government, legal, surveying or other professional advice.

SKETCH OF LAND: SP37612
PREVIOUS TITLE: 2188-946
PROPERTY STREET ADDRESS: UNIT 3 56 PAKENHAM ST, FREMANTLE.
LOCAL GOVERNMENT AUTHORITY: CITY OF FREMANTLE

HELD BY LANDGATE IN DIGITAL FORM ONLY.

FORM 1

SUBJECT	PURPOSE	STATUTORY REFERENCE	ORIGIN	LAND BURDENED	BENEFIT TO	COMMENTS
(A)	EASEMENT		DOC E817612	FREMANTLE TOWN LOT 441	LOT 500	RIGHT OF SUPPORT
(B)	EASEMENT		DOC H4-35764	FREMANTLE TOWN LOT 440	SP 37612	RIGHT OF SUPPORT

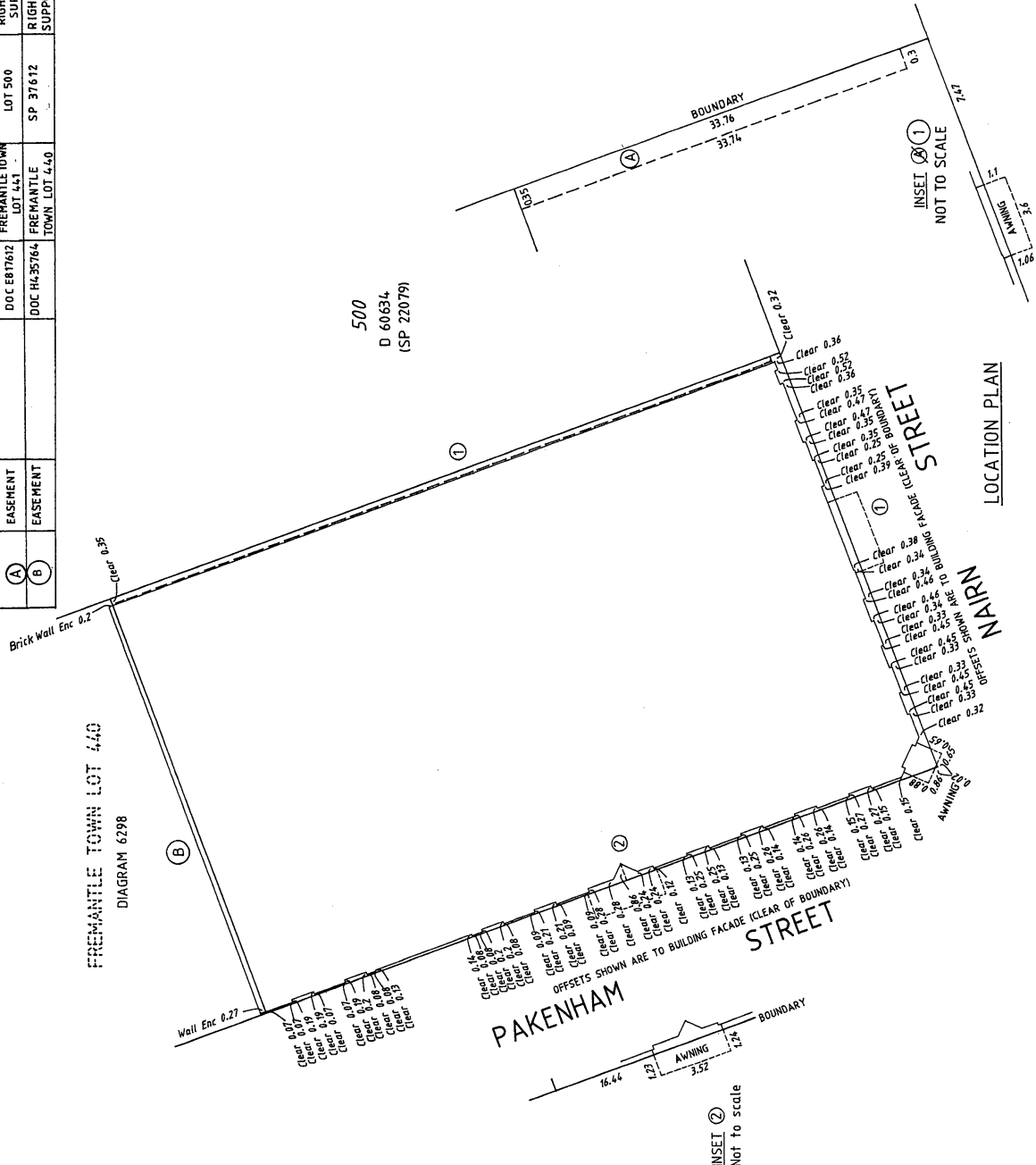

RD/EJT 1.2.01
4.614-02-V5 REV 1
\\61N46140200\CAD\02V5.DWG

Conc 52/2001 V13 pg 7

WARNING: CREASING OR FOLDING WILL LEAD TO REJECTION

STRATA/SURVEY PLAN 37612 SHEET 1 OF 4 SHEETS		MANAGEMENT STATEMENT <input checked="" type="checkbox"/> YES <input type="checkbox"/> NO
Lodged 28.08.2001 318120 Examined 28.8.01 Registered 28.8.01 App H 551828		
REGISTRAR OF TITLES WESTERN AUSTRALIAN PLANNING COMMISSION Certificate of Approval of W.A.P.C. under Section 264A or 264B of Strata Titles Act 1985		
FOR CHAIRMAN DATE 1-1-01		
PLAN OF RE-SUBDIVISION OF LOTS 1-6 & 8-16 INCLUSIVE ON STRATA PLAN 37612		
CERT. OF TITLE VOL 2188 FOL 944 - 949 VOL 2204 FOL 172 - 180 LOCAL GOVERNMENT CITY OF FREMANTLE INDEX PLAN BG34 (1) 12.25 & 12.26 FIELD BOOK NUMBER SCALE 1:200		
NAME OF SCHEME PAKENHAM APARTMENTS		
ADDRESS OF PARCEL No 56 PAKENHAM STREET (Cnr. of NAIRN STREET) FREMANTLE WA 6160		

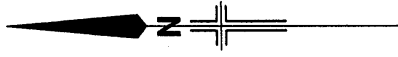

STRATA/SUBDIVISION

STRATA PLAN 37612

SHEET 2 OF 4 SHEETS

ON THE GROUND FLOOR THE STRATUM OF THE PART LOTS EXCLUDING COURTYARDS EXTENDS FROM THE UPPER SURFACE OF THE GROUND FLOOR TO THE LEVEL OF THE UNDERSIDE OF THE CEILING.

ON THE GROUND FLOOR THE STRATUM OF THE LOTS OR PART OF THE LOTS WHICH ARE BUILDINGS SHOWN ON THE STRATA PLAN EXTENDS FROM THE UPPER SURFACE OF THE GROUND FLOOR TO THE LEVEL OF THE UNDERSIDE OF THE CEILING, AS PROVIDED BY SECTION 3(2)(b) OF THE STRATA TITLES ACT 1985.

THE STRATUM OF THE PART LOTS WHICH ARE COURTYARDS EXTENDS FROM THE UPPER SURFACE OF THE FLOOR OF THE RESPECTIVE ADJOINING PART LOT TO 2.8 METRES ABOVE THE UPPER SURFACE OF THE FLOOR OF THE RESPECTIVE ADJOINING PART LOT UNLESS COVERED.

THE BOUNDARY OF THE LOTS OR PART LOTS WHICH ARE SHOWN ON THE STRATA PLAN IS THE CENTRELINE OF DIVIDING WALLS AND ON ALL EXTERNAL WALLS OF THE BUILDING THE BOUNDARY EXTENDS 0.1m INTO THE WALL FROM THE INSIDE FACE, OR WHERE OTHERWISE SHOWN.

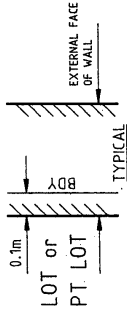

ALL ANGLES ARE MULTIPLES OF 45° UNLESS DEFINED BY A PERMANENT STRUCTURE, PERIMETER OF PARCEL, OR DEFINED OTHERWISE.

F INDICATES FACE OF WALL OR FACE OF WALL PRODUCED.

Δ INDICATES COURTYARD

⌋ INDICATES CENTRELINE OF WALL OR PILLAR PRODUCED.

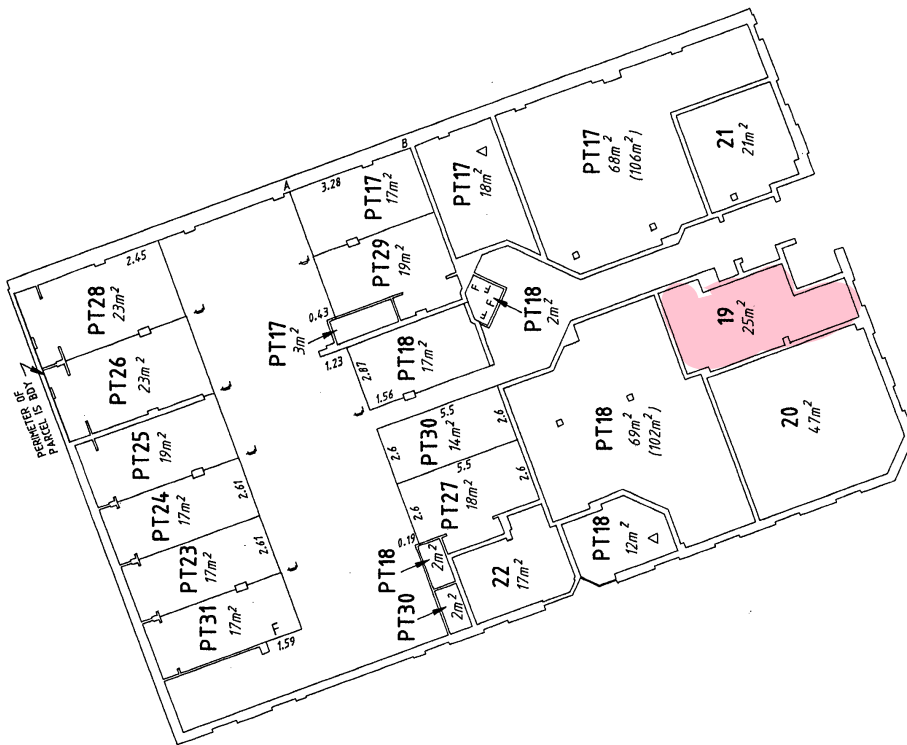

GROUND FLOOR

FOR OTHER PART LOTS 23 TO 31 INCLUSIVE SEE SHEETS 3 AND 4 OF 4 SHEETS



RD/EJT 23.11.01
4.614-02-V5 REV 2
N:\614\46140200\CAD\02V5A.DWG

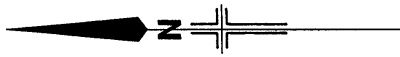

STRATA/SURVEY
~~STRATA~~ PLAN 37612

SHEET 3 OF 4 SHEETS

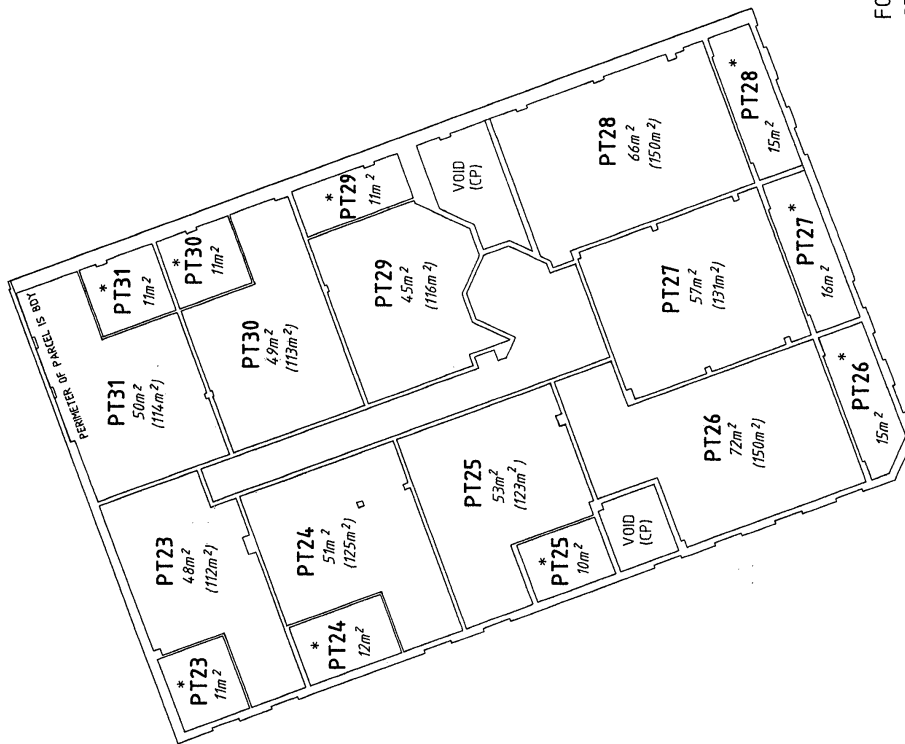

FIRST FLOOR

FOR OTHER PART LOTS 23 TO 31 INCLUSIVE
 SEE SHEETS 2 AND 4 OF 4 SHEETS

ON THE FIRST FLOOR THE STRATUM OF THE LOTS OR PART OF THE LOTS WHICH ARE BUILDINGS SHOWN ON THE STRATA PLAN EXTENDS FROM THE UPPER SURFACE OF THE FIRST FLOOR TO THE UNDERSIDE OF THE CEILING AS PROVIDED BY SECTION 3(2)(b) OF THE STRATA TITLES ACT 1985.

THE STRATUM OF THE PART LOTS WHICH ARE BALCONIES EXTENDS FROM THE UPPER SURFACE OF THE RESPECTIVE BALCONY FLOOR TO 6 METRES ABOVE THE UPPER SURFACE OF THE RESPECTIVE FLOOR LEVELS, UNLESS COVERED.

THE BOUNDARY OF THE LOTS OR PART LOTS WHICH ARE SHOWN ON THE STRATA PLAN IS THE CENTRELINE OF DIVIDING WALLS AND ON ALL EXTERNAL WALLS OF THE BUILDING THE BOUNDARY EXTENDS 0.1m INTO THE WALL FROM THE INSIDE FACE, OR WHERE OTHERWISE SHOWN.

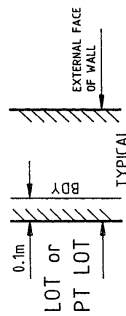

* INDICATES BALCONY





STRATA/SURVEY
STRATA PLAN 37612
 SHEET 4 OF 4 SHEETS

ON THE MEZZANINE FLOOR THE STRATUM OF THE LOTS OR PART OF THE LOTS WHICH ARE BUILDINGS SHOWN ON THE STRATA PLAN EXTENDS FROM THE UPPER SURFACE OF THE MEZZANINE FLOOR TO THE UNDERSIDE OF THE CEILING AS PROVIDED BY SECTION 3(2)(b) OF THE STRATA TITLES ACT 1985.

THE STRATUM OF THE PART LOTS WHICH ARE BALCONIES EXTENDS FROM THE UPPER SURFACE OF THE RESPECTIVE BALCONY FLOOR TO 3 METRES ABOVE THE UPPER SURFACE OF THE RESPECTIVE FLOOR LEVELS, UNLESS COVERED.

THE BOUNDARY OF THE LOTS OR PART LOTS WHICH ARE SHOWN ON THE STRATA PLAN IS THE CENTRELINE OF DIVIDING AND EXCEPT ON ALL EXTERNAL WALLS OF THE BUILDING THE BOUNDARY EXTENDS 0.1m INTO THE WALL FROM THE INSIDE FACE, OR WHERE OTHERWISE SHOWN.

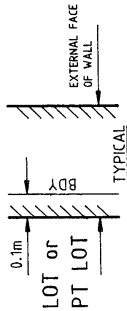

- * INDICATES BALCONY
- S INDICATES EDGE OF STAIRS
- E INDICATES EDGE OF FLOORING

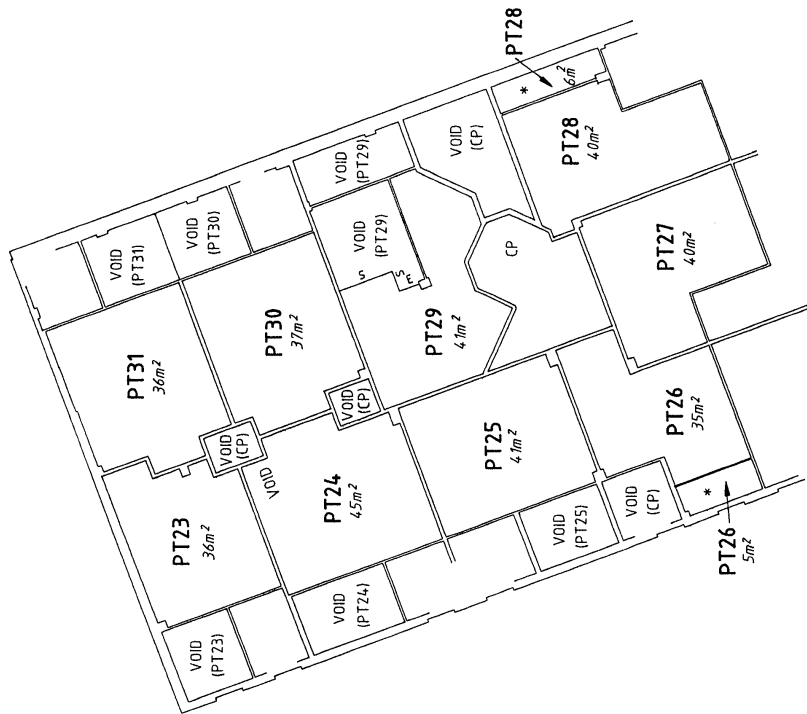

MEZZANINE FLOOR

FOR OTHER PART LOTS 23 TO 31 INCLUSIVE SEE SHEETS 2 & 3 OF 4 SHEETS

WARNING: CREASING OR FOLDING WILL LEAD TO REJECTION

Corr 5/2001 V13 pa 7

ANNEXURE OF STRATA PLAN No. 37612							
SCHEDULE OF UNIT ENTITLEMENT		OFFICE USE ONLY CURRENT Cs. of TITLE		SCHEDULE OF UNIT ENTITLEMENT		OFFICE USE ONLY CURRENT Cs. of TITLE	
LOT. No.	UNIT ENTITLEMENT	VOL.	FOL.	LOT. No.	UNIT ENTITLEMENT	VOL.	FOL.
1	Now re-subdivided			20	45	2510 - 204	
2	Now re-subdivided			21	19	2510 - 205	
3	Now re-subdivided			22	19	2510 - 206	
4	Now re-subdivided			23	81	2510 - 207	
5	Now re-subdivided			24	82	2510 - 208	
6	Now re-subdivided			25	82	2510 - 209	
7	Now re-subdivided			26	111	2510 - 210	
8	Now re-subdivided			27	90	2510 - 211	
9	Now re-subdivided			28	108	2510 - 212	
10	Now re-subdivided			29	67	2510 - 213	
11	Now re-subdivided			30	72	2510 - 214	
12	Now re-subdivided			31	72	2510 - 215	
13	Now re-subdivided						
14	Now re-subdivided						
15	Now re-subdivided						
16	Now re-subdivided						
17	64	2510 - 201					
18	64	2510 - 202					
19	24	2510 - 203		Aggregate	1000		

DESCRIPTION OF PARCEL AND BUILDING/PARCEL
BUILDING: THE BUILDING IS A BRICK, CONCRETE AND IRON CONSTRUCTION.

PARCEL: FREMANTLE TOWN LOT 441 CERTIFICATE OF TITLE VOLUME 1502 FOLIO 185.

**CERTIFICATE OF LICENSED VALUER
 STRATA**

I, PAUL A. SMITH, being a Licensed Valuer licensed under the *Land Valuers Licensing Act 1978* certify that the unit entitlement of each lot (in this certificate, excluding any common property lots), as stated in the schedule bears in relation to the aggregate unit entitlement of all lots delineated on the plan a proportion not greater than 5 per cent more or 5 per cent less than the proportion that the value (as that term is defined in section 14(2a) of the Strata titles act 1985) of that lot bears to the aggregate value of all the lots delineated on the plan.

26/11/2001
 Date

Paul A. Smith
 Signed

Corr 52 / 2001 V13 pg 7

FORM 5
Strata Titles Act 1985
Sections 5B(1), 8A, 22(1)

STRATA PLAN No. **37612**

DESCRIPTION OF PARCEL & BUILDING

PARCEL: RE-SUBDIVISION OF LOTS 1 TO 6 INCLUSIVE, AND LOTS 8 TO 16 INCLUSIVE, ON STRATA PLAN 37612

BUILDING: THE BUILDING IS A BRICK, CONCRETE AND IRON CONSTRUCTION

CERTIFICATE OF LICENSED SURVEYOR

I, RICHARD DELANY, being a licensed surveyor registered under the *Licensed Surveyors Act 1909*, certify that in respect of the strata plan which relates to the parcel and building described above (in this certificate called "the plan")—

- (a) each lot that is not wholly within a building shown on the plan is within the external surface boundaries of the parcel; and either
- (b) ~~each building shown on the plan is within the external surface boundaries of the parcel; or~~
- (c) in a case where a part of a wall or building, or material attached to a wall or building, encroaches beyond the external surface boundaries of the parcel—
 - (i) all lots shown on the plan are within the external surface boundaries of the parcel;
 - (ii) the plan clearly indicates the existence of the encroachment and it's nature and extent; and
 - (iii) where the encroachment is not on to a public road, street or way, that an appropriate easement has been granted and will be lodged with the Registrar of Titles to enable it to be registered as an appurtenance of the parcel; and

*(d) if the plan is a plan of re-subdivision, it complies with Schedule 1 by-law(s) No(s) **26 & 27** on Strata Plan No **37612** registered in respect of (name of scheme).....

PAKENHAM APARTMENTS or sufficiently complies with that/those by-law(s) in a way that is allowed by regulation 36 of the *Strata Titles General Regulations 1996*.

27.11.01

Date

Richard Delany

Licensed Surveyor



PH 9429 6666 Fax 9429 6555

"GHD House", 239 Adelaide Terrace Perth WA 6004
PO Box Y3106 Perth WA 6832 Australia

* Delete if inapplicable

Corr 52/2001 V13 pg 7

FORM 7

Strata Titles Act 1985

Section 5B(2), 8A(f), 23(1)

STRATA PLAN No. 37612

DESCRIPTION OF PARCEL & BUILDING

RE-SUBDIVISION OF LOTS 1-6 AND 8-16 INCLUSIVE ON STRATA PLAN 37612 EXISTING OVER FREMANTLE TOWN LOT 441

THE BUILDING IS OF BRICK, CONCRETE AND IRON CONSTRUCTION.

CERTIFICATE OF LOCAL GOVERNMENT

CITY OF FREMANTLE....., the local government hereby certifies that in respect of the strata plan which relates to the parcel and building described above (in this certificate called "the plan"):-

- (1) ~~*(a) the building and the parcel shown on the plan have been inspected and that it is consistent with the approved building plans and specifications in respect of the building; or~~
 *(b) the building has been inspected and the modification is consistent with the approved building plans and specifications relating to the modification;
- (2) the building, in the opinion of the local government, is of sufficient standard to be brought under the *Strata Titles Act 1985*;
- (3) where a part of a wall or building or material attached to a wall or building, encroaches beyond the external surface boundaries of the parcel on to a public road, street or way the local government is of the opinion that retention of the encroachment in its existing state will not endanger public safety or unreasonably interfere with the amenity of the neighbourhood and the local government does not object to the encroachment; and
- (4) *(a) any conditions imposed by the Western Australian Planning Commission have been complied with; or
~~*(b) the within strata scheme is exempt from the requirement of approval by the Western Australian Planning Commission.~~

24/5/2001.....
Date

[Signature]
.....
Chief Executive Officer

DIRECTOR, URBAN MANAGEMENT
AUTHORISED DELEGATE UNDER
SECTION 23(5) OF THE STRATA

*Delete if inapplicable

TITLES ACT 1985

Corr 52/2001 V13 pg 7

FORM 26

WAPC Ref. No. 1411-97

STRATA PLAN No. **37612**

STRATA TITLES ACT 1985
Sections 25(1), 25(4)

**CERTIFICATE OF GRANT OF APPROVAL BY WESTERN AUSTRALIAN
PLANNING COMMISSION TO STRATA PLAN**

It is hereby certified that the approval of the Western Australian Planning Commission has been granted pursuant to section 25(1) of the *Strata Titles Act 1985* to –

- * (i) the ~~*Strata Plan/Plan of Re-Subdivision/Plan of Consolidation~~ submitted...7.2.01..... and relating to the property described below;
- * (ii) ~~the sketch submitted on~~ of the * proposed subdivision of the property described below into lots on a Strata Plan / Re-Subdivision/~~Consolidation of the lots on the Strata Plan~~ described below, subject to the ~~following conditions~~

Property Description: Lot (or Strata Plan) No. SP 37612

Location FREMANTLE TOWN LOT 441

Locality FREMANTLE

Local Government CITY OF FREMANTLE

Lodged by: GHD SURVEYS PTY LTD
239 ADELAIDE TCE, PERTH, WA
 Date : 6.2.01

 For Chairman, Western Australian
 Planning Commission
 Date 7.2.01

(*To be deleted as appropriate)

col 52/2001 Vol 13 p 7

FORM 1

STRATA PLAN 37612

STRATA/SURVEY STRATA PLAN

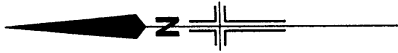

TOGETHER WITH A RIGHT OF SUPPORT AS SET OUT IN EASEMENT H435764.

FREMANTLE TOWN LOT 440

DIAGRAM 6298

500
DIAGRAM
60634

NOW RE-SUBDIVIDED

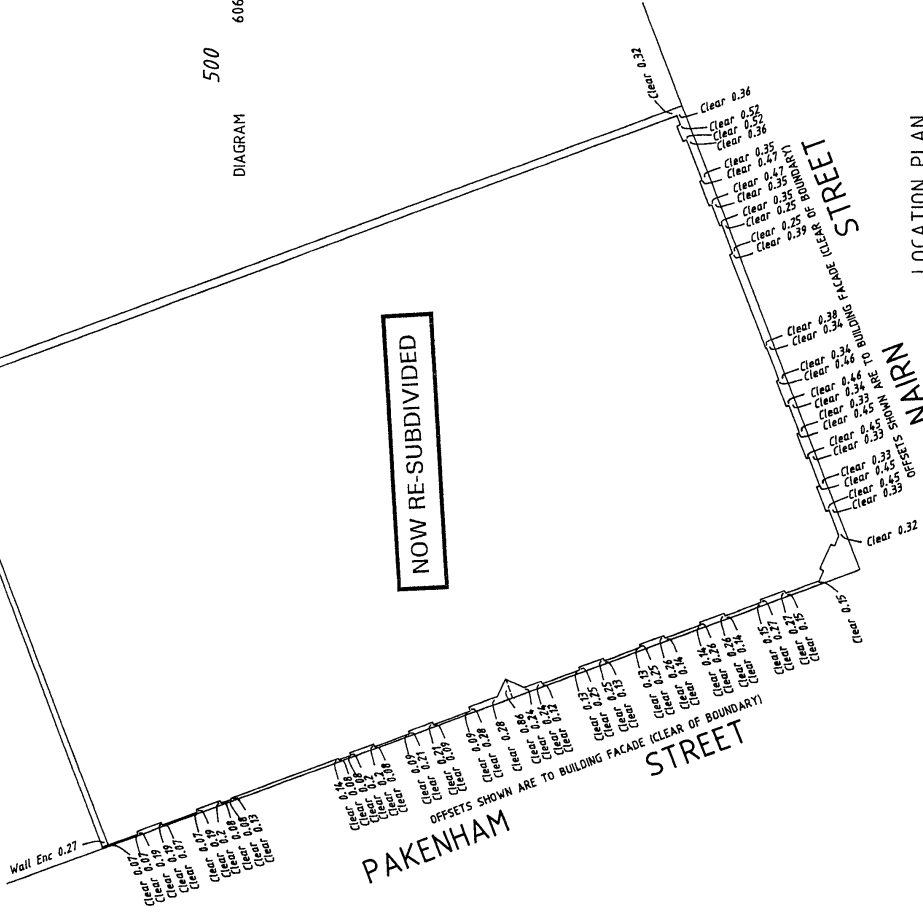

LOCATION PLAN

STREET

PAKENHAM STREET



WARNING: CREASING OR FOLDING WILL LEAD TO REJECTION

JD/EJT 26.6.00
4614-02-V4 REV 0
N:\11\4614\02\00\CAD\02\V4.DWG
GHD

STRATA/SURVEY STRATA PLAN 37612	
SHEET 1 OF 4 SHEETS	MANAGEMENT STATEMENT <input checked="" type="checkbox"/> YES <input type="checkbox"/> NO
Lodged 9/10/2000 287061 Examined 20/10/2000 B Registered 24/10/2000 JPH H 581251	REGISTRAR OF TITLES WESTERN AUSTRALIAN PLANNING COMMISSION Certificate of Approval of W.A.P.C. under Section 25(1) or 25B(2) of Strata Titles Act 1985 1411-77
FOR CHAIRMAN	DATE 20/7/00
PLAN OF RE-SUBDIVISION OF LOT 7 ON STRATA PLAN 37612	
CERT. OF TITLE SP 37612	LOCAL GOVERNMENT CITY OF FREMANTLE
INDEX PLAN BG34 (1) 12.25 & 12.26	FIELD BOOK NUMBER
SCALE 1:200	NAME OF SCHEME PAKENHAM APARTMENTS
ADDRESS OF PARCEL No 56 PAKENHAM STREET (COR. of NAIN STREET) FREMANTLE WA 6160	

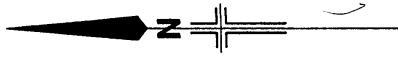

STRATA/SUBDIVISION PLAN 37612

SHEET 2 OF 4 SHEETS

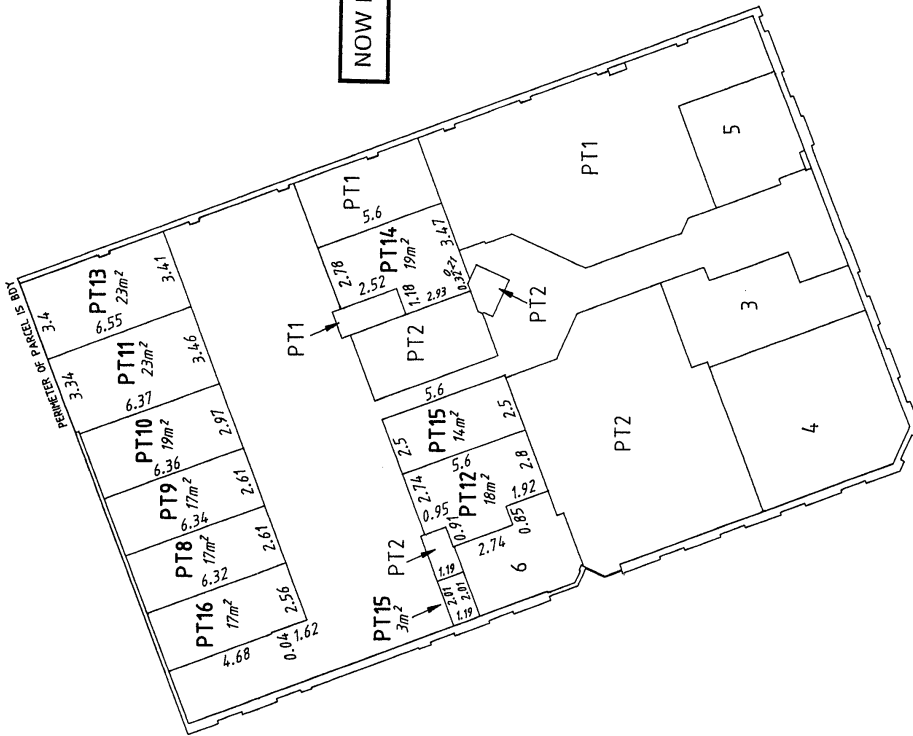

NOW RE-SUBDIVIDED

FOR OTHER PART LOTS 8 TO 16 INCLUSIVE
SEE SHEETS 3 AND 4 OF 4 SHEETS.

GROUND LEVEL

THE STRATUM OF LOTS 8-16 INCLUSIVE ON THE GROUND LEVEL, EXTENDS FROM THE LOWEST LEVEL OF THE UPPER SURFACE OF THE FLOOR SLAB ON THE GROUND LEVEL TO THE UNDERSIDE OF THE FIRST LEVEL FLOOR SLAB.

THE BOUNDARY OF THE LOTS OR PART LOTS WHICH ARE SHOWN ON THE STRATA PLAN EXTENDS 0.1m INTO THE EXTERNAL WALLS FROM THE INSIDE FACE, OR WHERE OTHERWISE SHOWN, AS PROVIDED BY SECTION 3(2)(b) OF THE STRATA TITLES ACT 1985.

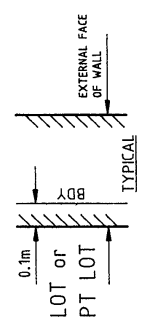

ALL ANGLES ARE MULTIPLES OF 45° UNLESS DEFINED BY A PERMANENT STRUCTURE, PERIMETER OF PARCEL OR SHOWN OTHERWISE.

DIMENSIONS ARE SHOWN TO THE INSIDE FACE OF EXTERNAL WALLS.

PT LOTS 1-6 SHOWN AS ABUTTALS ON THIS STRATA PLAN AND CREATED ON STRATA PLAN FOR STAGE ONE.



WARNING: CREASING OR FOLDING WILL LEAD TO REJECTION



JD/EJT 26-6.00
4614-02-V4 REV 0
N:\11\6616200\CAD\03V4A.DWG



NOW RE-SUBDIVIDED

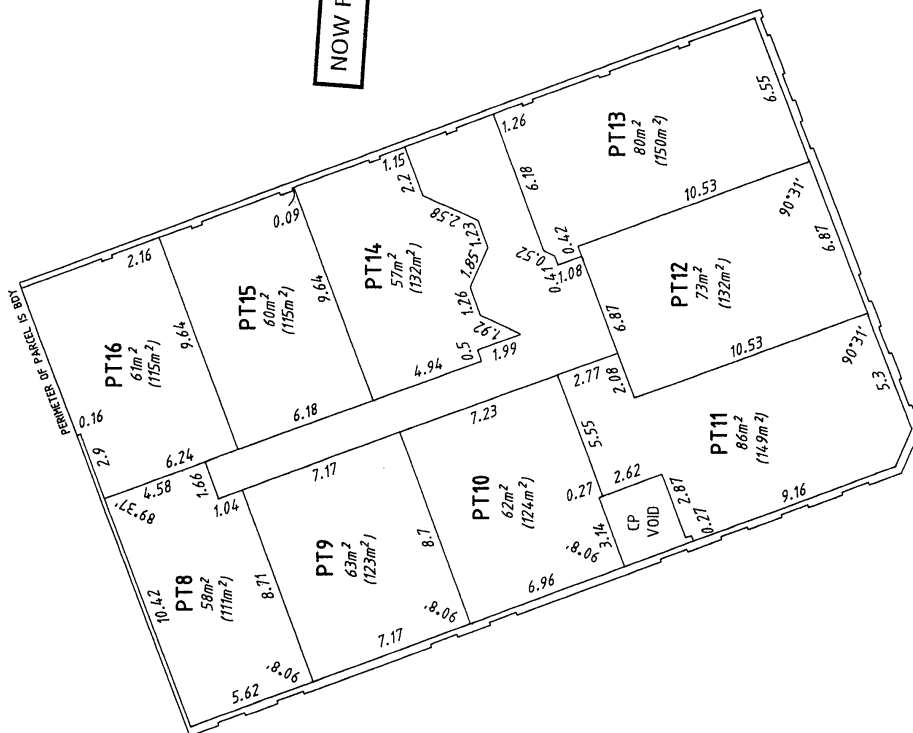

FOR OTHER PART LOTS 8 TO 16 INCLUSIVE
SEE SHEETS 2 AND 4 OF 4 SHEETS

FIRST LEVEL

STRATA/SURVEY
~~SURVEY~~ PLAN 37612
SHEET 3 OF 4 SHEETS

SLAB
FIRST

THE STRATUM OF PART LOTS 8 TO 16 ON THE FIRST FLOOR EXTENDS FROM THE UPPER SURFACE OF THE FLOOR TO 8 METRES ABOVE THE UPPER SURFACE OF THE FIRST FLOOR SLAB UNLESS COVERED.

THE BOUNDARY OF THE LOTS OR PART LOTS WHICH ARE SHOWN ON THE STRATA PLAN EXTENDS 0.1m INTO THE EXTERNAL WALLS FROM THE INSIDE FACE, OR WHERE OTHERWISE SHOWN, AS PROVIDED BY SECTION 3(2)(b) OF THE STRATA TITLES ACT 1985.

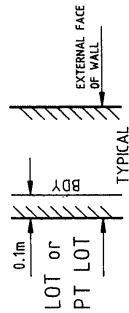

ALL ANGLES ARE MULTIPLES OF 45° UNLESS DEFINED BY A PERMANENT STRUCTURE, PERIMETER OF PARCEL OR SHOWN OTHERWISE.

DIMENSIONS ARE SHOWN TO THE INSIDE FACE OF EXTERNAL WALLS.

CP INDICATES COMMON PROPERTY



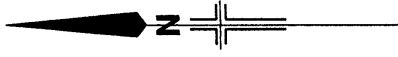

NOW RE-SUBDIVIDED

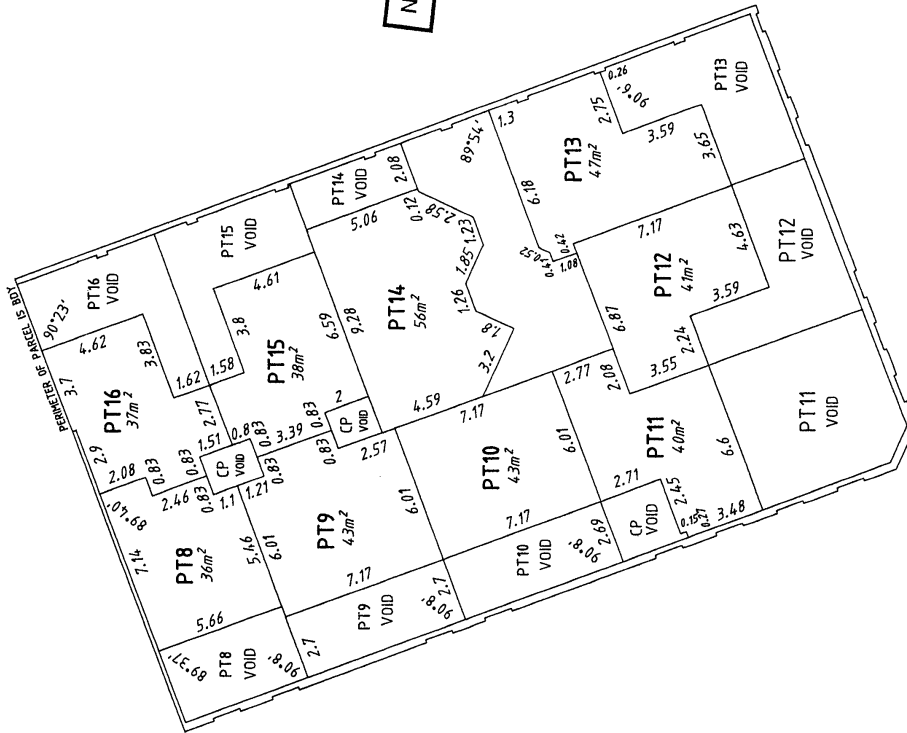

FOR OTHER PART LOTS 8 TO 16 INCLUSIVE
SEE SHEETS 2 AND 3 OF 4 SHEETS

MEZZANINE LEVEL

STRATA/SUBDIVISION PLAN 37612

SHEET 4 OF 4 SHEETS

THE STRATUM OF LOTS 8 TO 16 INCLUSIVE ON THE MEZZANINE LEVEL, EXTENDS FROM THE UPPER SURFACE OF THE FLOOR TO 5 METRES ABOVE THE UPPER SURFACE OF THE FLOOR OF THE RESPECTIVE LOTS ON THE MEZZANINE LEVEL.

THE BOUNDARY OF THE LOTS OR PART LOTS WHICH ARE SHOWN ON THE STRATA PLAN EXTENDS 0.1m INTO THE EXTERNAL WALLS FROM THE INSIDE FACE, OR WHERE OTHERWISE SHOWN, AS PROVIDED BY SECTION 3(2)(b) OF THE STRATA TITLES ACT 1985.

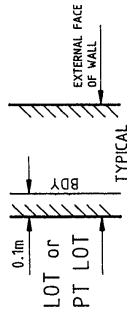

ALL ANGLES ARE MULTIPLES OF 45° UNLESS DEFINED BY A PERMANENT STRUCTURE, PERIMETER OF PARCEL OR SHOWN OTHERWISE.

DIMENSIONS ARE SHOWN TO THE INSIDE FACE OF EXTERNAL WALLS.

CP DENOTES COMMON PROPERTY.



WARNING: CREASING OR FOLDING WILL LEAD TO REJECTION

ANNEXURE 'D' OF STRATA PLAN No. 37612							
SCHEDULE OF UNIT ENTITLEMENT		OFFICE USE ONLY CURRENT Cs. of TITLE		SCHEDULE OF UNIT ENTITLEMENT		OFFICE USE ONLY CURRENT Cs. of TITLE	
LOT. No.	UNIT ENTITLEMENT	VOL.	FOL.	LOT NO.	UNIT ENTITLEMENT	VOL.	FOL.
1	56			10	80	2204 - 174	
2	58			11	119	2204 - 175	
3	29			12	91	2204 - 176	
4	55			13	109	2204 - 177	
5	24			14	57	2204 - 178	
6	26			15	65	2204 - 179	
7	Now re-subdivided			16	65	2204 - 180	
8	87	2204 - 172					
9	79	2204 - 173		Aggregate	1,000		

DESCRIPTION OF PARCEL AND BUILDING/PARCEL

RE-SUBDIVISION OF LOT 7 ON STRATA PLAN 37612

**CERTIFICATE OF LICENSED VALUER
STRATA**

I, PAUL A. SMITH, being a Licensed Valuer licensed under the *Land Valuers Licensing Act 1978* certify that the unit entitlement of each lot (in this certificate, excluding any common property lots), as stated in the schedule bears in relation to the aggregate unit entitlement of all lots delineated on the plan a proportion not greater than 5 per cent more or 5 per cent less than the proportion that the value (as that term is defined in section 14(2a) of the Strata titles act 1985) of that lot bears to the aggregate value of all the lots delineated on the plan.

24/7/2000
Date

SEE FURTHER SHEET OF
PLAN OF RE-SUBDIVISION

Signed

FORM 5

STRATA PLAN No. 37612

DESCRIPTION OF PARCEL & BUILDING

RE-SUBDIVISION OF LOT 7 ON STRATA PLAN 37612

CERTIFICATE OF LICENSED SURVEYOR

I, RICHARD DELANY, being a licensed surveyor registered under the Licensed Surveyors Act 1909, certify that in respect of the strata plan which relates to the parcel and building described above (in this certificate called "the plan")—

- (a) each lot that is not wholly within a building shown on the plan is within the external surface boundaries of the parcel; and either
(b) each building shown on the plan is within the external surface boundaries of the parcel; or
(c) in a case where a part of a wall or building, or material attached to a wall or building, encroaches beyond the external surface boundaries of the parcel—
(i) all lots shown on the plan are within the external surface boundaries of the parcel;
(ii) the plan clearly indicates the existence of the encroachment and it's nature and extent; and
(iii) where the encroachment is not on to a public road, street or way, that an appropriate easement has been granted and will be lodged with the Registrar of Titles to enable it to be registered as an appurtenance of the parcel; and

* (d) if the plan is a plan of re-subdivision, it complies with Schedule 1 by-law(s) No(s) on Strata Plan No. registered in respect of (name of scheme) or sufficiently complies with that/those by-law(s) in a way that is allowed by regulation 36 of the Strata Titles General Regulations 1996.

5.10.2000
Date

[Signature]
Licensed Surveyor

* Delete if inapplicable

FORM 7

Strata Titles Act 1985

Section 5B(2), 8A(f), 23(1)

STRATA PLAN No. 37612

DESCRIPTION OF PARCEL & BUILDING

RE SUBDIVISION OF LOT 7 ON STRATA PLAN 37612 EXISTING OVER
FREMANTLE TOWN LOT 441

CERTIFICATE OF LOCAL GOVERNMENT

CITY OF FREMANTLE....., the local government hereby
certifies that in respect of the strata plan which relates to the parcel and
building described above (in this certificate called "the plan"):-

(1) *(a) the building and the parcel shown on the plan have been inspected
and that it is consistent with the approved building plans and
specifications in respect of the building; or

~~*(b) the building has been inspected and the modification is consistent
with the approved building plans and specifications relating to the
modification;~~

(2) the building, in the opinion of the local government, is of sufficient
standard to be brought under the *Strata Titles Act 1985*;

~~(3) where a part of a wall or building or material attached to a wall or
building, encroaches beyond the external surface boundaries of the
parcel on to a public road, street or way the local government is of the
opinion that retention of the encroachment in its existing state will not
endanger public safety or unreasonably interfere with the amenity of
the neighbourhood and the local government does not object to the
encroachment; and~~

(4) *(a) any conditions imposed by the Western Australian Planning
Commission have been complied with; or

~~*(b) the within strata scheme is exempt from the requirement of approval
by the Western Australian Planning Commission.~~

4/10/2000.....
Date

Acting Chief Executive Officer

*Delete if inapplicable

JD/EJT 26.4.00
4614-02-V3 REV 2
\\G11\4614020\CAD\02\03.DWG

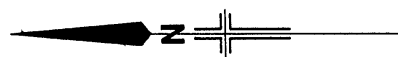

TOGETHER WITH A RIGHT OF SUPPORT AS SET OUT IN EASEMENT H435764.

FREMANTLE TOWN LOT 440
DIAGRAM 6298

500
DIAGRAM
60634

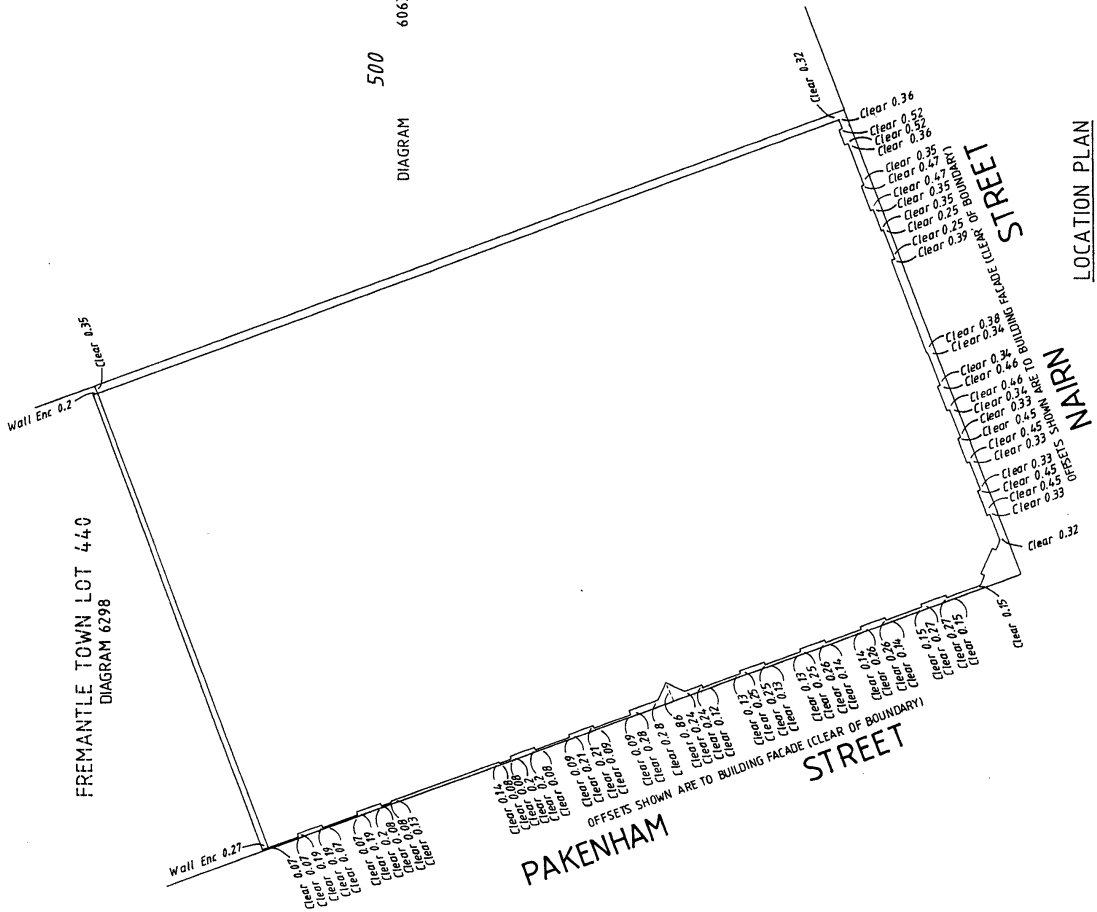

LOCATION PLAN

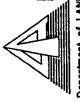

WARNING: CREASING OR FOLDING WILL LEAD TO REJECTION

STRATA/SURVEY	
STRATA PLAN 37612	
SHEET 1 OF 4 SHEETS	
MANAGEMENT STATEMENT	<input checked="" type="checkbox"/> YES <input type="checkbox"/> NO
Lodged 23.2.2000 266701	
Examined 27.4.2000 SHH	
Registered 4.5.2000 Application H435764	
REGISTRAR OF TITLES	
WESTERN AUSTRALIAN PLANNING COMMISSION	
Certificate of Approval of W.A.P.C. under Section 25(1) or 25B(2)* of Strata Titles Act 1985	
FOR CHAIRMAN	DATE 1.2.00
PLAN OF	
FREMANTLE TOWN LOT 441	
CERT. OF TITLE	VOL 2188 FOL 943
LOCAL GOVERNMENT	CITY OF FREMANTLE
INDEX PLAN	BG34 (1) 12.25 & 12.26
FIELD BOOK NUMBER	
SCALE	1:200
NAME OF SCHEME	PAKENHAM APARTMENTS
ADDRESS OF PARCEL	No 56 PAKENHAM STREET (COR. of NAIRN STREET) FREMANTLE WA 6160
 DEPARTMENT OF LAND ADMINISTRATION	

* COK 92 / 2000 V61 3 P 33

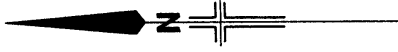

FOR CROSS SECTIONS A-A, B-B AND C-C
SEE SHEET 3 OF 4 SHEETS.
FOR CROSS SECTIONS D-D AND E-E
SEE SHEET 4 OF 4 SHEETS.

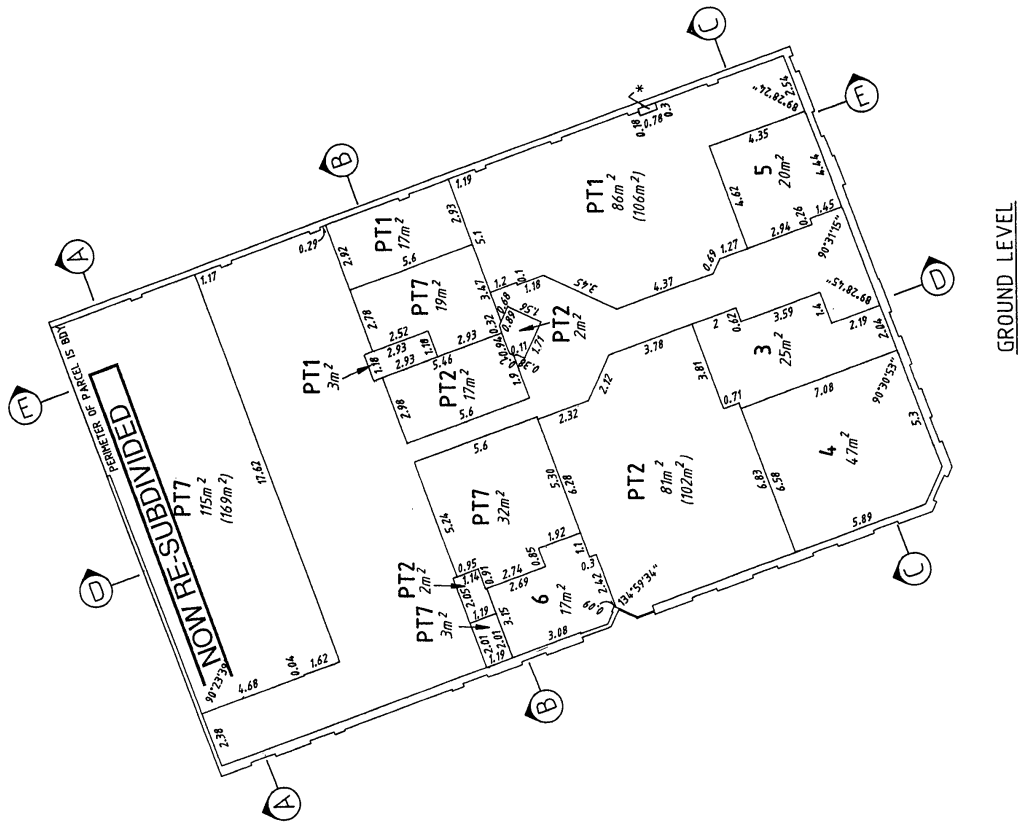

STRATA/SURVEY
STRATA PLAN 37612
SHEET 2 OF 4 SHEETS

THE STRATUM OF LOTS 1 TO 6 INCLUSIVE ON THE GROUND LEVEL, EXTENDS FROM THE LOWEST LEVEL OF THE UPPER SURFACE OF THE FLOOR SLAB ON THE GROUND LEVEL TO 2.8m ABOVE THE LOWEST LEVEL OF THE UPPER SURFACE OF THE FLOOR SLAB ON THE GROUND LEVEL.

THE STRATUM OF PART LOTS 7 EXTENDS FROM 5m BELOW THE LOWEST LEVEL OF THE UPPER SURFACE OF THE FLOOR SLAB ON THE GROUND LEVEL TO 12.8m ABOVE THE UPPER SURFACE OF THE FLOOR SLAB ON THE GROUND LEVEL, EXCEPT WHERE ABOVE LOTS 1 TO 6 INCLUSIVE, WHERE THE STRATUM EXTENDS FROM 2.8m ABOVE THE LOWEST LEVEL OF THE UPPER SURFACE OF THE FLOOR SLAB ON THE GROUND LEVEL TO 12.8m ABOVE THE LOWEST LEVEL OF THE UPPER SURFACE OF THE FLOOR SLAB ON THE GROUND LEVEL.

THE BOUNDARY OF THE LOTS OR PART LOTS WHICH ARE SHOWN ON THE STRATA PLAN IS THE CENTRELINE OF THE PROPOSED DIVIDING WALLS (AS SHOWN BY DIMENSION) EXCEPT ON ALL EXTERNAL WALLS WHERE THE BOUNDARY EXTENDS 0.1m INTO THE WALL FROM THE INSIDE FACE, OR WHERE OTHERWISE SHOWN, AS PROVIDED BY SECTION 3(2)(b) OF THE STRATA TITLES ACT 1985.

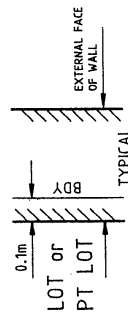

AN * INDICATES A PROPOSED DUCT OR A PROPOSED PILLAR AND THESE ARE EXCLUDED FROM THE UNIT LOT AREA.

ALL ANGLES ARE MULTIPLES OF 45° UNLESS DEFINED BY A PERMANENT STRUCTURE, PERIMETER OF PARCEL OR SHOWN OTHERWISE.



WARNING: CREASING OR FOLDING WILL LEAD TO REJECTION

STRATA/SURVEY
 STRATA PLAN 37612
 SHEET 3 OF 4 SHEETS

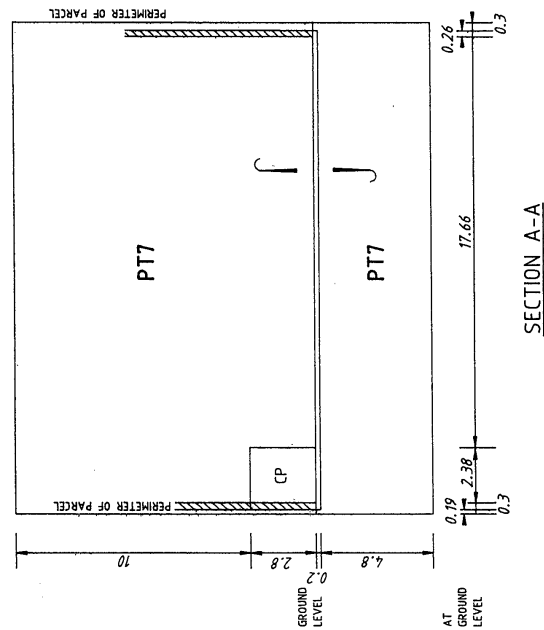

SECTION A-A

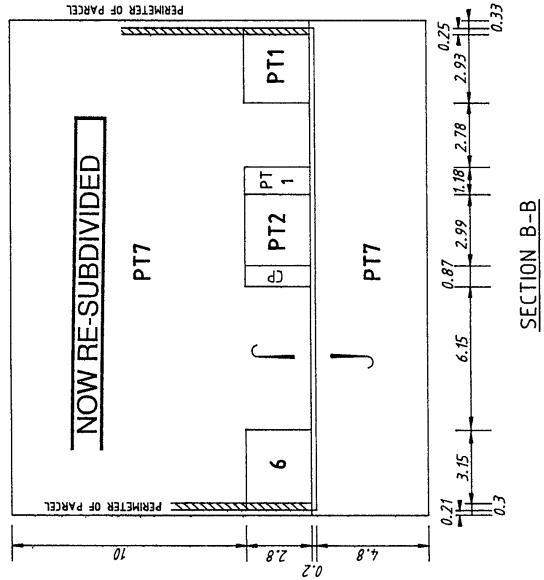

SECTION B-B

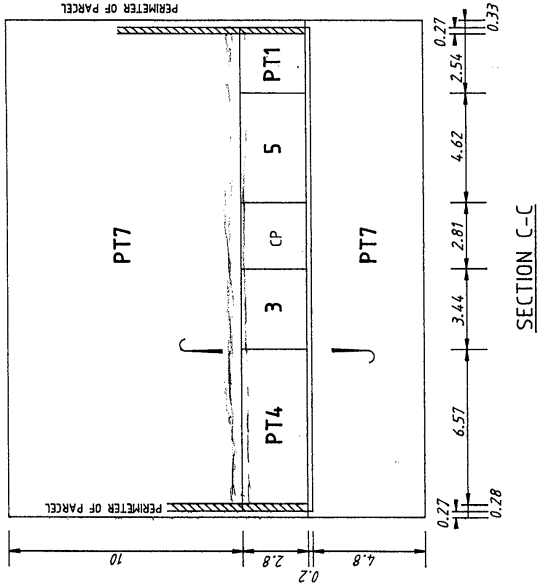

SECTION C-C

NOTE:
 1. CP = COMMON PROPERTY



STRATA/SURVEY
 STRATA PLAN 37612
 SHEET 4 OF 4 SHEETS

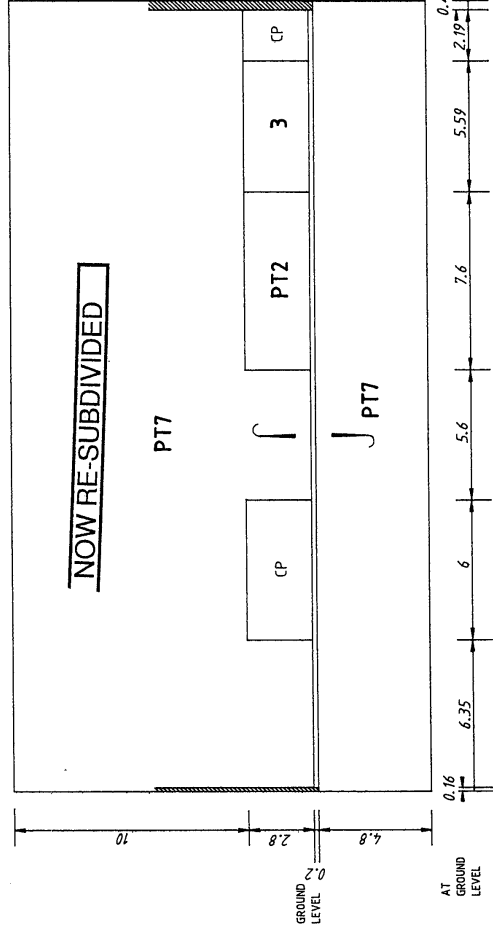

SECTION D-D

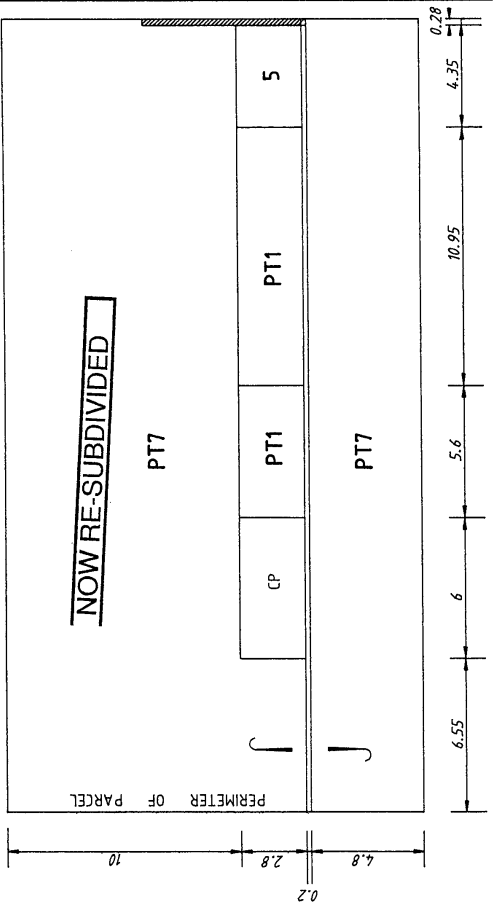

SECTION E-E

NOTE:
 1. CP = COMMON PROPERTY

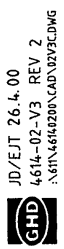

WARNING: CREASING OR FOLDING WILL LEAD TO REJECTION

ANNEXUREA..... OF STRATA PLAN No. 37612

SCHEDULE OF UNIT ENTITLEMENT		OFFICE USE ONLY CURRENT Cs. of TITLE		SCHEDULE OF UNIT ENTITLEMENT		OFFICE USE ONLY CURRENT Cs. of TITLE	
LOT No.	UNIT ENTITLEMENT	VOL.	FOL.	LOT NO.	UNIT ENTITLEMENT	VOL.	FOL.
1.	56	2188 - 944		6	26	2188 - 949	
2	58	2188 - 945		7	752	2188 - 950	
3	29	2188 - 946					
4	55	2188 - 947					
5	24	2188 - 948		Aggregate	1,000		

DESCRIPTION OF PARCEL AND BUILDING/PARCEL

FREMANTLE TOWN LOT 441.

CERTIFICATE OF LICENSED VALUER STRATA

I, PAUL A. SMITH, being a Licensed Valuer licensed under the Land Valuers Licensing Act 1978 certify that the unit entitlement of each lot (in this certificate, excluding any common property lots), as stated in the schedule bears in relation to the aggregate unit entitlement of all lots delineated on the plan a proportion not greater than 5 per cent more or 5 per cent less than the proportion that the value (as that term is defined in section 14(2a) of the Strata titles act 1985) of that lot bears to the aggregate value of all the lots delineated on the plan.

2/3/2000
Date

Paul A. Smith
Signed

FORM 5

STRATA PLAN No. 37612

DESCRIPTION OF PARCEL & BUILDING

PARCEL : FREMANTLE TOWN LOT 441. THE ADDRESS OF THE PARCEL IS No.56 PAKENHAM STREET FREMANTLE WA 6160
BUILDING : THE BUILDING ON THE PARCEL IS A BRICK AND CONCRETE CONSTRUCTION

CERTIFICATE OF LICENSED SURVEYOR

I, PAUL LEE BEAVER, being a licensed surveyor registered under the Licensed Surveyors Act 1909, certify that in respect of the strata plan which relates to the parcel and building described above (in this certificate called "the plan")—

- (a) each lot that is not wholly within a building shown on the plan is within the external surface boundaries of the parcel; and either
(b) each building shown on the plan is within the external surface boundaries of the parcel; or
(c) in a case where a part of a wall or building, or material attached to a wall or building, encroaches beyond the external surface boundaries of the parcel—
(i) all lots shown on the plan are within the external surface boundaries of the parcel;
(ii) the plan clearly indicates the existence of the encroachment and it's nature and extent; and
(iii) where the encroachment is not on to a public road, street or way, that an appropriate easement has been granted and will be lodged with the Registrar of Titles to enable it to be registered as an appurtenance of the parcel; and

* (d) if the plan is a plan of re-subdivision, it complies with Schedule 4 by law(s) No(s) on Strata Plan No registered in respect of (name of scheme) or sufficiently complies with that/those by law(s) in a way that is allowed by regulation 36 of the Strata Titles General Regulations 1996.

28-2-00

Date

Handwritten signature of Paul Lee Beaver

Licensed Surveyor

* Delete if inapplicable

COPL 52 / 2000 Vol 3 p 33

FORM 7

Strata Titles Act 1985

Section 5B(2), 8A(f), 23(1)

STRATA PLAN No. 37612

DESCRIPTION OF PARCEL & BUILDING

PARCEL : FREMANTLE TOWN LOT 441. THE ADDRESS OF THE PARCEL IS No. 56 PAKENHAM STREET, FREMANTLE WA 6160
BUILDING : THE BUILDING ON THE PARCEL IS A BRICK AND CONCRETE CONSTRUCTION.

CERTIFICATE OF LOCAL GOVERNMENT

CITY OF FREMANTLE

....., the local government hereby certifies that in respect of the strata plan which relates to the parcel and building described above (in this certificate called "the plan"):-

- (1) *(a) the building and the parcel shown on the plan have been inspected and that it is consistent with the approved building plans and specifications in respect of the building; or
*(b) the building has been inspected and the modification is consistent with the approved building plans and specifications relating to the modification;
(2) the building, in the opinion of the local government, is of sufficient standard to be brought under the Strata Titles Act 1985;
(3) where a part of a wall or building or material attached to a wall or building, encroaches beyond the external surface boundaries of the parcel on to a public road, street or way the local government is of the opinion that retention of the encroachment in its existing state will not endanger public safety or unreasonably interfere with the amenity of the neighbourhood and the local government does not object to the encroachment; and
(4) *(a) any conditions imposed by the Western Australian Planning Commission have been complied with; or
*(b) the within strata scheme is exempt from the requirement of approval by the Western Australian Planning Commission.

25/2/2000
Date

[Signature]
Chief Executive Officer

*Delete if inapplicable

DIRECTOR, URBAN MANAGEMENT

FORM 8

ANNEXURE B OF STRATA / SURVEY STRATA PLAN No. 37612 REGISTRAR OF TITLES

SCHEDULE OF DEALINGS ON STRATA / SURVEY STRATA PLAN

Dealings registered or recorded on Strata / Survey Strata Plan	Instrument			Signature of Registrar of Titles
	Nature	Number	Regist'd Time	
Re-Subdivision of lot 7 to lots 8 to 16 inc	Application	H581261	24.10.00 11.45	<i>[Signature]</i>
Re-subdivision of lots 1 to 6 & 8 to 16 inc to lots 17 to 31 inc	Application	H851828	28.08.01 9.38	<i>[Signature]</i>

Note: Entries may be affected by subsequent endorsements.

FORM 8

REGISTRAR OF TITLES

ANNEXURE C OF STRATA / SURVEY STRATA PLAN No. **37612**

SCHEDULE OF ENCUMBRANCES ETC.

Instrument		Regist'd	Signature of Registrar of Titles	Cancellation			
Nature	Number			Nature	Number	Regist'd	Time
Transfer	E817612						
<p> </p>							
STATEMENT	H435767	4.5.00					
Notification	I856944	19.4.04	<i>RS Robyn</i>				
Memorial	O174041	18.6.2019	<i>[Signature]</i>				

Note: Entries may be affected by subsequent endorsements.

Strata Plan 37612

Lot	Certificate of Title	Lot Status	Part Lot
1	2188/944 (Cancelled)	Retired	
2	2188/945 (Cancelled)	Retired	
3	2188/946 (Cancelled)	Retired	
4	2188/947 (Cancelled)	Retired	
5	2188/948 (Cancelled)	Retired	
6	2188/949 (Cancelled)	Retired	
7	N/A	Retired	
8	2204/172 (Cancelled)	Retired	
9	2204/173 (Cancelled)	Retired	
10	2204/174 (Cancelled)	Retired	
11	2204/175 (Cancelled)	Retired	
12	2204/176 (Cancelled)	Retired	
13	2204/177 (Cancelled)	Retired	
14	2204/178 (Cancelled)	Retired	
15	2204/179 (Cancelled)	Retired	
16	2204/180 (Cancelled)	Retired	
17	2510/201	Registered	
18	2510/202	Registered	
19	2510/203	Registered	
20	2510/204	Registered	
21	2510/205	Registered	
22	2510/206	Registered	
23	2510/207	Registered	
24	2510/208	Registered	
25	2510/209	Registered	
26	2510/210	Registered	
27	2510/211	Registered	
28	2510/212	Registered	
29	2510/213	Registered	
30	2510/214	Registered	
31	2510/215	Registered	

FORM B 4

FORM APPROVED
NO. B2582

H 851828 A

28 Aug, 2001 09:38:33 Perth



REG. \$ 75.00
PROD. \$ 91.50
FEES \$ 166.50

APPLICATION FOR RE-SUBDIVISION
BY STRATA COMPANY

LODGED BY *ANDERSON SMITH CONSULTING*

ADDRESS *PO Box 646
WEST PERTH 6872*

PHONE No. *9226 3000*

FAX No. *9226 3317*

REFERENCE No.

ISSUING BOX No. *R262*

PREPARED BY *ANDERSON SMITH CONSULTING*

ADDRESS *AS ABOVE.*

PHONE No.

FAX No.

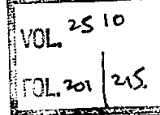

INSTRUCT IF ANY DOCUMENTS ARE TO ISSUE TO OTHER THAN
LODGING PARTY.

218/944 DUP. C/T PRODUCED 25/7/01
Box 126 all produced

TITLES, LEASES, DECLARATIONS ETC. LODGED HERewith

1.	<i>10 x titles produced</i>	Received Items
2.	_____	Nos.
3.	_____	
4.	_____	
5.	_____	
6.	_____	Receiving Clerk <i>[Signature]</i>

Registered pursuant to the provisions of the TRANSFER OF LAND
ACT 1893 as amended on the day and time shown above and
particulars entered in the Register.

EXAMINED *[Signature]*



[Star symbol]

FORM 20

APPLICATION FOR RE-SUBDIVISION BY STRATA COMPANY

Strata Titles Act 1985

Sections 8A, 18 & 19

THE OWNERS OF PAKENHAM APARTMENTS - STRATA PLAN No. 37612 request that the Registrar of Titles register this strata plan of re-subdivision and confirm that:-

*(b) the plan of re-subdivision complies with Schedule 1 by-laws nos. 26 and 27 on Strata Plan No. 37812 or sufficiently complies with those by-laws in a way that is allowed by regulation 36 of the *Strata Titles General Regulations 1996*.

Details of the relevant rating authorities to be notified by the Registrar of Titles are as follows:

Local Government.

Name: CITY OF FREMANTLE
Address: P O BOX 807, FREMANTLE WA 6959.
Facsimile No.: 9430 4634

Water Authority.

Name: WATER CORPORATION
Address: 629 NEWCASTLE STREET, LEEDERVILLE 6007
Facsimile No.: 9420 3200

Sewerage Authority.

Name: WATER CORPORATION
Address: 629 NEWCASTLE STREET, LEEDERVILLE 6007
Facsimile No.: 9420 3200

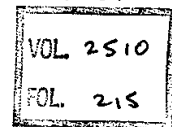
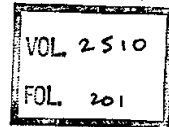

CONSENT BY PERSONS HAVING REGISTERED INTERESTS AND CAVEATORS (IF ANY)
TO PROPOSED ALLOCATION OF UNIT ENTITLEMENT

ENCUMBRANCE Document & No.

The Common Seal of **THE OWNERS OF PAKENHAM APARTMENTS**
STRATA PLAN No. 37612 was affixed hereto
on 22/8/01 in the presence of:

B W Farrington

P. W. Smith

Members of the Council



File Copy Do Not Destroy

Stopped Document Disposal Instructions

Fees to be Refunded	Document Type	Fee \$
Form 10 No.:		
Date:		
To:		
Address:		
Parties:		
Reference:		
Document Numbers:		
Computer Records Adjusted: <u>Mainframe</u> - WDR/MTF/DPA/BKC <u>SMR</u> - WFR or REJECT		
Documents to be Rejected:		
Documents to be Withdrawn:		
Documents for Registration: H 851828		
Caveats to be made Null & Void:		
Authorised by: CWD		

Stopped Case:851828

Original Cs/T:
2188-944, 2188-945, 2188-946, 2188-947, 2188-948, 2188-949, 2204-172, 2204-173, 2204-174, 2204-175, 2204-176, 2204-177, 2204-178, 2204-179, 2204-180

Notice Sent:

Action:

Examiner's notes:

Examination Instructions

Allocate New C/T
Complete Nom. Index
Pass to
Other

Group 1

Examiner: PGW, SREX11

Supervisor: ,

Requisition Notice

Document Nos: H851828

Section 192 of the Transfer of Land Act

Your Ref: STRATA PLAN 37612

First and Final

Our Ref: PHIL WYSS Ph: 9273 7458 Fax: 9273 7668

Date: 7 December 2001

Lodging Party:

Other Parties Contacted:

ANDERSON SMITH CONSULTING

Registration of the above documents cannot be effected until all requisitions listed below are complied with and the fee payable is received.
A time limit of 14 days applies from the date stated above.

Requisitions

Doc. No	Description	Req. Fee
H851828	Duplicate certificates of title, (Title Deed), Volume.2188. Folio.947 and Volume 2204 Folio's 172, 173, 174, 175, 176, 178, 179 and 180 must be produced with this document. *	50.00
H851828	As lot(s)1, 4, 8, 9, 10, 11, 12, 14, 15, and 16 are directly affected by the re-subdivision, consents of all encumbrancers are required. (See paragraphs 6.4.9 of the Land Titles Registration Practice Manual). <i>Not Required</i>	00.00
Requisition Sub Total \$		50.00
Additional Fee \$		0.00
TOTAL FEE Payable \$		50.00

* These dups. were in the office until recently, they were reissued to Banks due to the 3 month time limit in productions. (The strata plan had a long standing requisition in L.B.S.)
- DOLA has agreed to cover the costs of re-producing the dups. concerned. (Referred to M. McGlenn and F. Calgineri).
- Therefore requisition is annulled.

Ian Hyde
Registrar of Titles

Requisitions may be attended to by ;

1. fax direct to the Examiner referred to above.
2. personal attendance DOLA, Midland Square. (all documents held at Midland Office)
3. the lodging of evidence at DOLA's Perth Branch Office, Mt Newman House, 200 St. Georges Terrace, Perth or Bunbury Regional Office 61 Victoria St, Bunbury (note: no advice/discussions re: requisitions)
4. Post to P O Box 2222, Midland WA 6936 or DX95

Correspondence by representatives of parties to documents **must state** the capacity in which they act and confirm that they are duly authorised to do so. Amendment by letter is at the discretion of the Registrar of Titles.

Unless these requisitions are complied with, the documents will be rejected. Upon notification of such rejection half the registration fees paid are forfeitable. Documents may be withdrawn from registration, for which a withdrawal fee of \$37.50 per document is payable. Registration fees returnable in full or in part will be set-off against requisition and withdrawal fees.
See payment options on page 2.

CWJ
12/12/01

OFFICE USE ONLY

I 856944 AE

19 Apr, 2004 14:12:14 Midland



REG. \$ 77.00

LODGED BY BELL COURT STRATA MANAGEMENT

ADDRESS PO Box 1659

SUBIACO WA 6904

PHONE No. 9486-1866

FAX No. 9486-1868

REFERENCE No.

ISSUING BOX No. 999L

PREPARED BY

ADDRESS

PHONE No.

FAX No.

INSTRUCT IF ANY DOCUMENTS ARE TO ISSUE TO OTHER THAN LODGING PARTY

TITLES, LEASES, DECLARATIONS ETC LODGED HERewith

- 1. _____ Received Items
- 2. _____ Nos.
- 3. _____
- 4. _____
- 5. _____
- 6. _____ Receiving Clerk *LP*

Registered pursuant to the provisions of the TRANSFER OF LAND ACT 1893 as amended on the day and time shown above and particulars entered in the Register.

MM
EXAMINED



FORM 21

NOTIFICATION OF CHANGE OF BY-LAWS

Strata Titles act 1985

Section 42

The Owners of **Pakenham Apartments** -Strata Plan 37612 hereby certifies-

That by resolution without dissent duly passed at a meeting of the Strata Company on Wednesday, 4th February 2004 -which became unconditional on 3rd March 2004, the by-laws in Schedule 1 to the Act as they applied to the Strata Company, were amended as follows-

BY-LAW 31

It was resolved by resolution without dissent the by-laws to schedule 1 of the Strata Titles Act 1985 be added to as follows

If a proprietor fails, refuses and / or neglects to pay any contributions determined to be due and payable by the Proprietor under section 36 of the Act, the Proprietor becomes liable in respect of any legal costs, charges or expenses associated with the demand or recovery of the contributions by the Strata Company or its lawful representative jointly and severally with any person who was liable to pay the contribution

That by special resolution at a meeting of the Strata Company on Wednesday, 4th February 2004, the by-laws in Schedule 2 to the Act as they applied to the Strata Company, were amended as follows-

BY-LAW 21

It was resolved by special resolution the by-laws to schedule 2 of the Strata Titles Act 1985 be added to as follows

Penalty for Breach of Bylaws

Any person who breaches any Schedule 1 or 2 bylaw is, subject to Section 42A(2) of the Act, liable to pay a penalty of \$400.00 or such other amount as is prescribed by the Act from time to time"

The Common Seal of the Owners of **Pakenham Apartments** -Strata Plan 37612 was hereunto affixed on _____ 2004 in the presence of-



Member of the Council

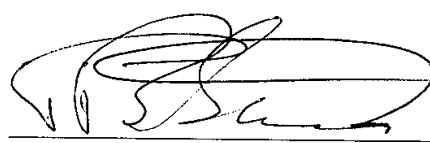

Member of the Council



FORM B 4

FORM APPROVED
NO. B2582

H 581261 A

24 Oct, 2000 11:45:02 Perth



REG. \$ 70.00
PROD. \$ 35.00
FEES \$ 105.00

APPLICATION FOR RE-SUBDIVISION
BY STRATA COMPANY

**SMART
REGISTER**

SOLOMON BROTHERS
LVL 40,
EXCHANGE PLAZA
2 THE ESPRANADE, PERTH 6000

PHONE No. 9221 5888

FAX No. 4221 5955

REFERENCE No.

ISSUING BOX No. 46x

PREPARED BY

ADDRESS

PHONE No.

FAX No.

VOL 2204
FOL 12/180

INSTRUCT IF ANY DOCUMENTS ARE TO ISSUE TO OTHER THAN
LODGING PARTY.

DUP. C/T PRODUCED

CBA 54

2188. ~~747~~ 950

TITLES, LEASES, DECLARATIONS ETC. LODGED HEREWITH

1.	part of consent	Received Items
2.	_____	Nos.
3.	_____	
4.	_____	
5.	_____	
6.	_____	Receiving Clerk

Registered pursuant to the provisions of the TRANSFER OF LAND
ACT 1893 as amended on the day and time shown above and
particulars entered in the Register.

EXAMINED

re address in

CONSENT BY PERSONS HAVING REGISTERED INTERESTS AND CAVEATORS (IF ANY)
TO PROPOSED ALLOCATION OF UNIT ENTITLEMENT

ENCUMBRANCE Document & No.

Lot 1, 2 & 7 - Mortgage No. H337241 to National Australia Bank Ltd.
Lot 4 - Mortgage No. H473247 to Commonwealth Bank of Australia.

See attached consents.

The Common Seal of **THE OWNERS OF PAKENHAM APARTMENTS**
STRATA PLAN No. 37612 was affixed hereto
on 7/8/2000 in the presence of:

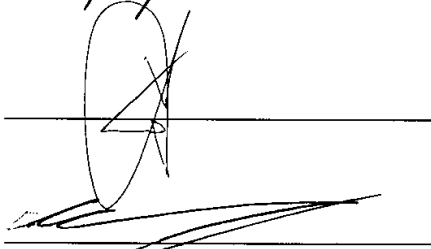

Members of the Council



FORM 20

APPLICATION FOR RE-SUBDIVISION BY STRATA COMPANY

Strata Titles Act 1985

Sections 8A, 18 & 19

THE OWNERS OF PAKENHAM APRTMENTS - STRATA PLAN No. 37612 request that the Registrar of Titles register this strata plan of re-subdivision and confirm that:-

- (a) (i) it has by unanimous resolution consented to ---
- (I) the re-subdivision of lot 7 to create lots 8 to 16, inclusive;
 - (II) the proposed aggregate unit entitlement; and
 - (III) the proposed allocation of unit entitlement set out below;
- and

2188 | 950

- (ii) it has by resolution without dissent consented to the acquisition or transfer by the strata company of any common property, as provided for in the plan of re-subdivision.

PROPOSED ALLOCATION OF UNIT ENTITLEMENT

Lot No.	Proposed Unit Entitlement	Lot No.	Proposed Unit Entitlement
1	56	10	80
2	58	11	119
3	29	12	91
4	55	13	109
5	24	14	57
6	26	15	65
7	Now re-subdivided	16	65
8	87		
9	79	Aggregate:	1000

418
VOL 2204
FOL 172

lot 16
VOL 2204
FOL 180

Details of the relevant rating authorities to be notified by the Registrar of Titles are as follows:

Local Government.

Name: CITY OF FREMANTLE
Address: P O BOX 807, FREMANTLE 6959.
Facsimile No.: 9430 4634

Water Authority.

Name: WATER CORPORATION
Address: 629 NEWCASTLE STREET, LEEDERVILLE 6007
Facsimile No.: 9420 3200

Sewerage Authority.

Name: WATER CORPORATION
Address: 629 NEWCASTLE STREET, LEEDERVILLE 6007
Facsimile No.: 9420 3200

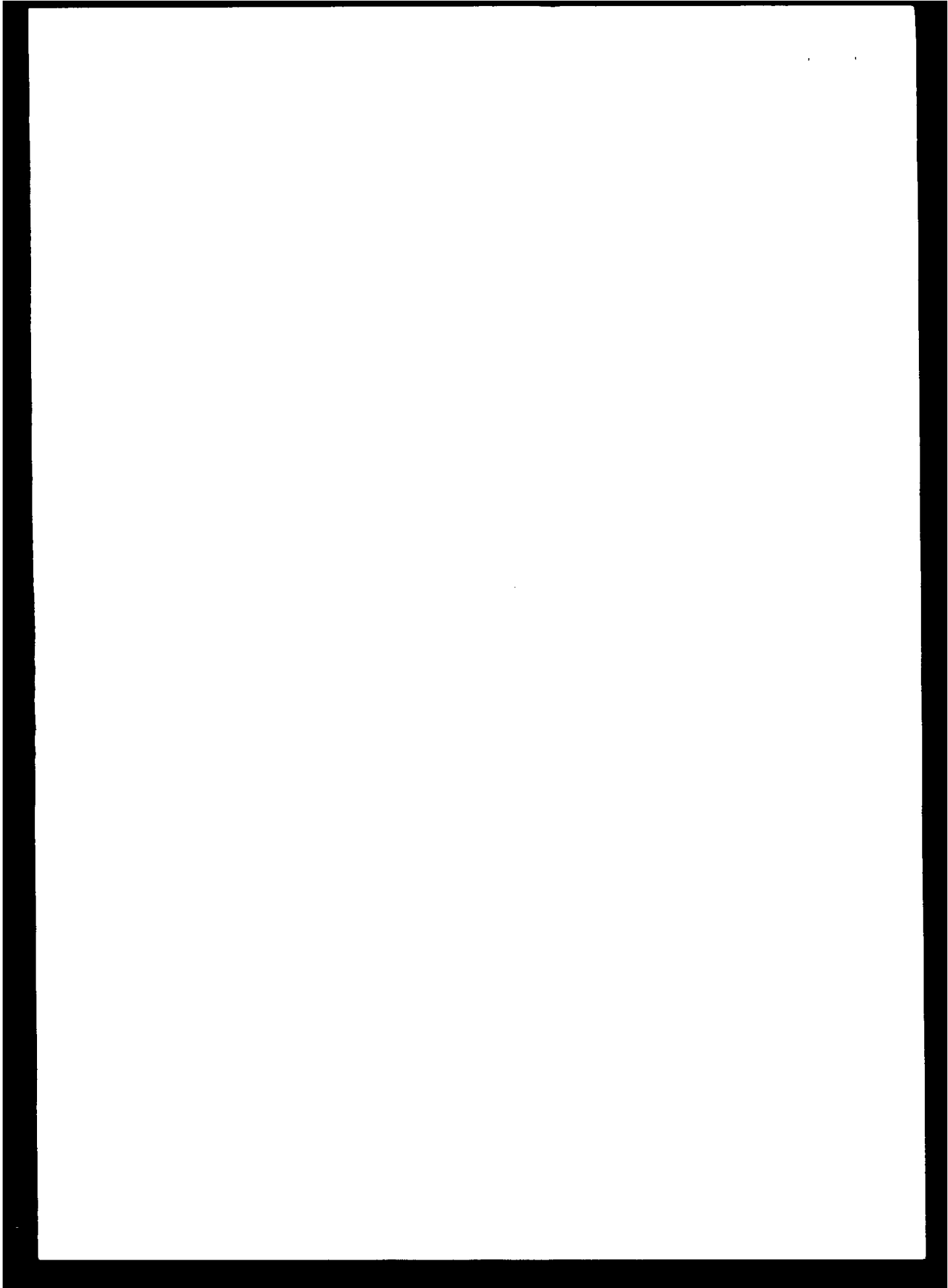

CERTIFICATE OF CONSENT

STRATA TITLES ACT 1985 as amended.

SECTION 8A.

Pursuant to the provisions of the Strata Titles Act 1985, as amended, we the undersigned, having a registered interest over the property described in **Item 1 of the Schedule** hereto pursuant to a mortgage described in **Item 2 of the Schedule** hereto hereby consent to the re-subdivision of the lots and common property described in **Item 3 of the Schedule** hereto and the proposed re-allocation of the unit entitlement as set out in **Item 4 of the Schedule** hereto as is contained in the "Application for Re-subdivision by Strata Company" of the strata plan.

SIGNATURE:

Witness:

BRADLEY WAYNE BIELAWSKI

Name:

BRADLEY WAYNE BIELAWSKI
of the Commonwealth Bank of Australia
acting as agent on behalf of the said Bank

COMMONWEALTH BANK OF AUSTRALIA
By its Attorney

Address:

in the presence of

Occupation:

Member of the said Bank

Senior
Conveyancing Officer
P/A F494304

SCHEDULE

Item 1: Lot 4 on Strata Plan No. 37612 comprising Certificate of Title Volume 2188 Folio 947.

Item 2: Mortgage No. H473247 to Commonwealth Bank of Australia.

Item 3: Re-subdivision of Lot 7 on Strata Plan No. 37612 to create Lots 8 to 16, inclusive.

Item 4: PROPOSED RE-ALLOCATION OF UNIT ENTITLEMENT

Lot No.	Proposed Unit Entitlement	Lot No.	Proposed Unit Entitlement
1	56	10	80
2	58	11	119
3	29	12	91
4	55	13	109
5	24	14	57
6	26	15	65
7	Now re-subdivided	16	65
8	87		
9	79	Aggregate:	1000

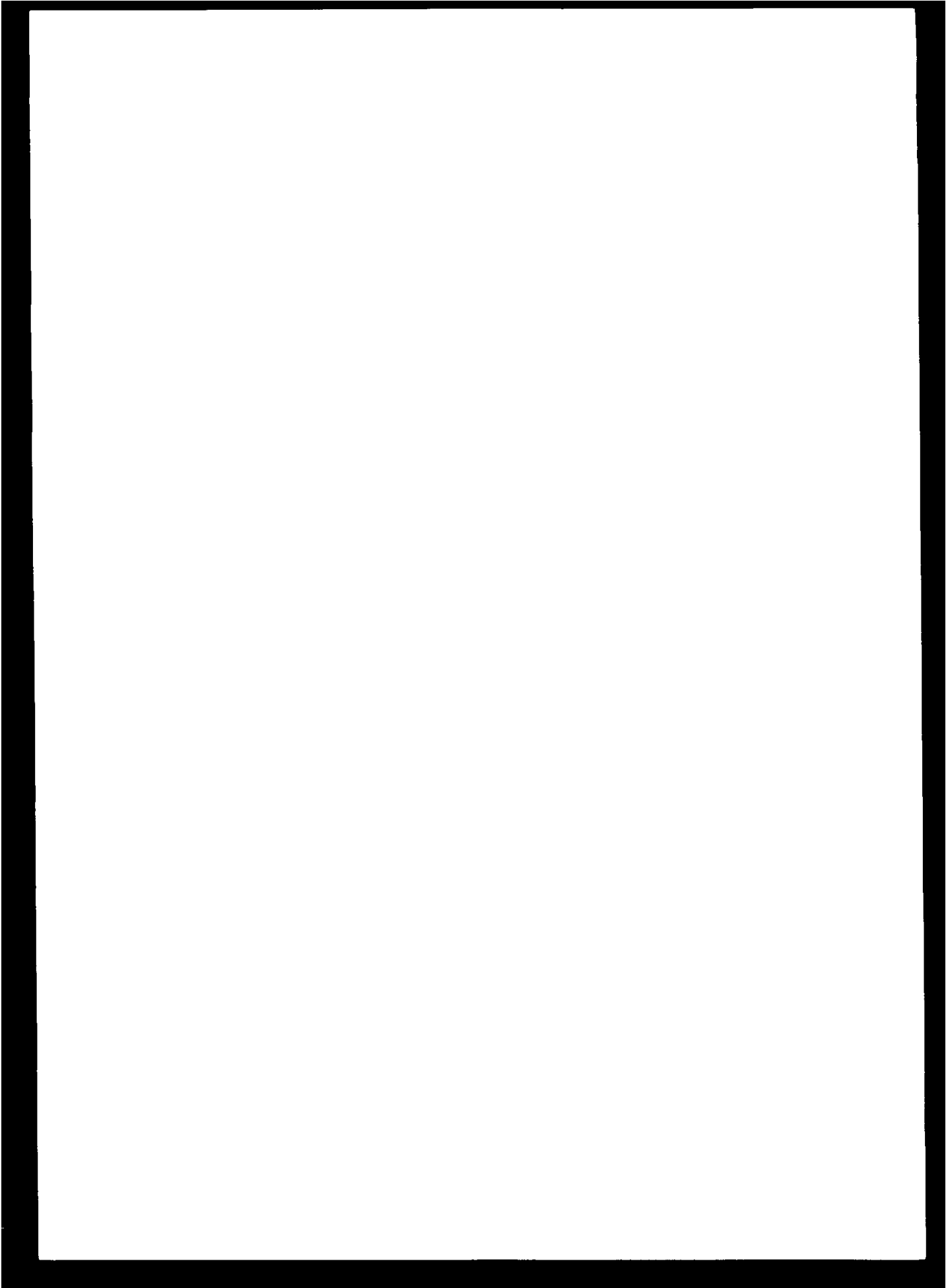

CERTIFICATE OF CONSENT

STRATA TITLES ACT 1985 as amended.

SECTION 8A.

Pursuant to the provisions of the Strata Titles Act 1985, as amended, we the undersigned, having a registered interest over the property described in **Item 1 of the Schedule** hereto pursuant to a mortgage described in **Item 2 of the Schedule** hereto hereby consent to the re-subdivision of the lots and common property described in **Item 3 of the Schedule** hereto and the proposed re-allocation of the unit entitlement as set out in **Item 4 of the Schedule** hereto as is contained in the "Application for Re-subdivision by Strata Company" of the strata plan.

SIGNATURE:

Executed by NATIONAL AUSTRALIA BANK LIMITED ABN 12 604 644 997 by being signed in Western Australia by its Attorney
DAVID DOUGLAS HAROLD LOW
under Power of Attorney No. 5666042
(who declares that he holds the office in the Bank indicated under his signature) in the presence of

NATIONAL AUSTRALIA BANK LIMITED
By its Attorney

MANAGER, BUSINESS BANKING SECURITIES

Witness:



Witness:

Name:

Address:

Occupation:

SCHEDULE

Item 1: Lots 1, 2 and 7 on Strata Plan No. 37612 comprising Certificates of Title Volume 2188 Folios 944, 945 and 950, respectively.

Item 2: Mortgage No. H337241 to National Australia Bank Ltd.

Item 3: Re-subdivision of Lot 7 on Strata Plan No. 37612 to create Lots 8 to 16, inclusive.

Item 4: PROPOSED RE-ALLOCATION OF UNIT ENTITLEMENT

Lot No.	Proposed Unit Entitlement	Lot No.	Proposed Unit Entitlement
1	56	10	80
2	58	11	119
3	29	12	91
4	55	13	109
5	24	14	57
6	26	15	65
7	Now re-subdivided	16	65
8	87		
9	79	Aggregate:	1000

No.

FEES (office use)

\$

¢

E 817612 E



REG. \$ 60.00

Parties

STOPPED FEE *817612*

ASS NO *30432 & 30*

Lodged by

Address **MARK BALFOUR & ASSOCIATES**
SUITE 5, 24 RISELEY STREET
Phone No. **ARDROSS WA 6153**
PH: (09) 364 9922 BOX 49.

Use this space for instructions if any documents are to issue to other than lodging party.

(1) 8

Titles, Crown Leases, Declarations, etc., lodged with this document. (To be filled in by person lodging.)

- 1. *Del. Sub. case* } Received items
- 2. *C/T 1502/185* }
- 3. } No's
- 4. }
- 5. }
- 6. } Rec. Clerk. *[Signature]*

BELOW THIS LINE FOR OFFICE USE ONLY

Encumbrances not notified on face.

New Titles to issue or Endorsing instruction.

EXAMINED.

E65931/12/88-2M-MS/1107

Note! Limited to building Demolition of building ME 38

LT14 4/3/92

Initials of Signing Officer.

[Signature]

Lodged on the day and time shown in and particular entered in the Register Book.

[Signature]

NT173

SIGNED AND SEALED by)
the said GEOFFREY MICHAEL)
BEATY in the presence of:)

[Handwritten signature]
2 NELSON ST
SOUTH FREMANTLE
WAITER

SIGNED AND SEALED by)
the said PAMELA HOPE)
FENNER in the presence of:)

[Handwritten signature]
2 NELSON ST SOUTH FREMANTLE
WAITER

THE COMMON SEAL of)
JORDANIA PTY. LTD. was)
hereunto affixed by)
authority of the)
Directors in the)
presence of :)

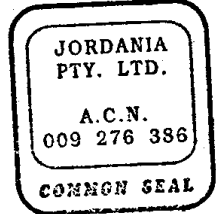

..... *[Handwritten signature]*
DIRECTOR
..... *[Handwritten signature]*
DIRECTOR/SECRETARY

"A"

EASEMENT EX FREMANTLE TOWN LOT 441

ENLARGEMENT
Not to scale

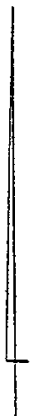
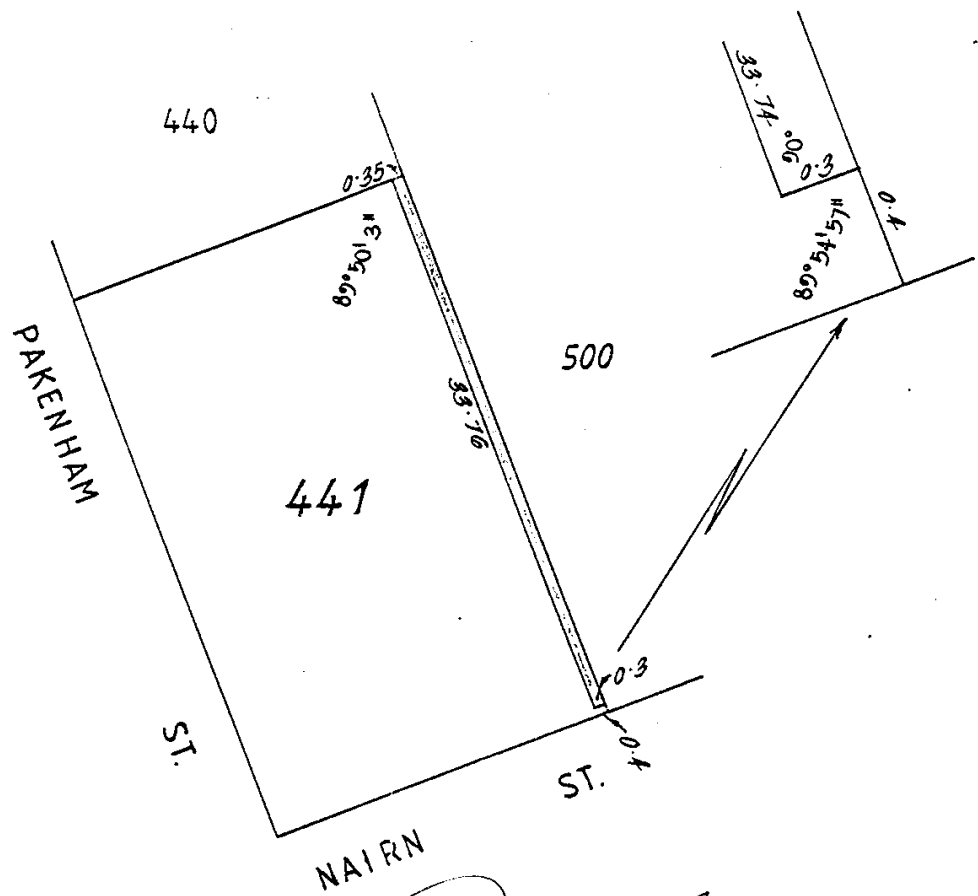

Scale 1 : 400

[Handwritten signatures]



NOW THIS DEED WITNESSETH as follows :-

1. In consideration of the payment of the sum of Ten Dollars (\$10.00) by the Grantee to the Grantor (receipt of which the Grantor hereby acknowledges) the Grantor DOES HEREBY GRANT to the registered proprietor or proprietors for the time being and from time to time of Lot 500 on Diagram 60634 the full and free right and liberty to enjoy an easement of support to permit and suffer the Building to be supported by that portion of the Building on that part of the Servient Tenement as is more particularly delineated and coloured blue on the Plan bound herewith and marked with the letter "A".
2. The easement granted by this Deed shall commence at the date of its execution by the Grantor and shall expire on the date of demolition of the Building. On the expiration of the easement granted by this Deed the Grantee shall execute all such documents as may be necessary to surrender the easement granted by this Deed and to have the same registered on the Title to the Servient Tenement.
3. The Grantee shall indemnify the Grantor from and against all loss damages costs and expenses which the Grantor may suffer or incur as a result or consequence of the Grantee exercising the rights conferred on the Grantee by this Deed.
4. The Grantee shall pay the Grantor's costs of and incidental to the negotiations of the terms of this Deed and all costs incurred in relation to the registration of this Deed at the Office of Titles, Perth, including but without limitation, in attending to satisfying any requisitions issued thereby.

IN WITNESS whereof the parties have hereunto executed these presents as a Deed the day and year first hereinbefore written.

WESTERN AUSTRALIA STAMP DUTY
18/02/92 7645305 SD \$*****5.00

WESTERN AUSTRALIA.
Transfer of Land Act 1893 as amended
Blank Instrument Form (see footnote)

No.

a. Insert type of document here.

e. EASEMENT.....

THIS DEED is made the 15th day of December One thousand nine hundred and ninety one.

B E T W E E N :

JORDANIA PTY. LTD. of Ground Floor, 8/10 The Esplanade, Perth in the State of Western Australia (hereinafter referred to as "the Grantor" of the first part;

A N D :

GEOFFREY MICHAEL BEATY and PAMELA HOPE FENNER both of 17 Stevens Street, Fremantle in the said State (hereinafter referred to as "the Grantees" of the second part.

W H E R E A S :

The Grantor is registered as the proprietor of an estate in fee simple in all that piece of land being Fremantle Town Lot 441 and being the whole of the land comprised in Certificate of Title Volume 1502 Folio 185 (herein "the Servient Tenement") and which land is more particularly delineated on the Plan bound herewith and marked with the letter "A".

STATE TAXATION
18 FEB 1992
DEPT. OF TREASURY

A N D W H E R E A S :

The Grantees are registered as the proprietors as tenants in common in equal shares of the fee simple estate in Fremantle Town Lot 442 and portion of each of Fremantle Town Lots 438, 439 and 443 the whole of the said land being Lot 500 on Diagram 60634 and being the whole of the land comprised in Certificate of Title Volume 1598 Folio 353 (herein "the Dominant Tenement") and the western boundary of which lot adjoins the eastern boundary of the Servient Tenement.

A N D W H E R E A S :

The building substantially constructed and erected upon the Dominant Tenement as at the date of this Deed ("the Building") is erected upon that part of the Servient Tenement as is more particularly coloured blue on the Plan bound herewith and marked with the letter "A".

A N D W H E R E A S :

The Grantor has agreed to grant to the Grantees an easement over that portion of the Servient Tenement as is more particularly delineated and coloured blue on the Plan bound herewith and marked with the letter "A" upon the terms and conditions hereinafter appearing.

GARRY L. DUFFIELD
GOVERNMENT
PRINTER
WESTERN AUSTRALIA
©

NOTE: This Form may be used only when the "Box Type" Form is not suitable. It may be completed in narrative style.

FILE COPY DO NOT DESTROY

FILE COPY DO NOT DESTROY

STOPPED DOCUMENT DISPOSAL INSTRUCTIONS

Fees to be Refunded \$ _____

Form 10 No _____

Date ____/____/19____

To _____

Parties _____

Document Numbers _____

Computer Records Adjusted

Docs to be Withdrawn:—

Docs to be Rejected:—

Docs for Registration:—

Authorised by:— *[Signature]*

STOPPED CASE:— 817612

ORIG. Cs/T:— 1502-185 846-52
1598-354
1598-353

NOTICE SENT:— ~~MAR 1992~~

ACTION:— = 9 MAR 1992

M.B. 188 RM 16 13/3
Letter for upliffing inside
618/616 upliffed 18/3.
Am 13

Iron Tansyui sketches to be
amended Am.

EXAMINATION INSTRUCTIONS

Allocate New C/T

Complete Nom. Index

Pass To NT

Other _____

Examiner P. Crowe

Supervisor [Signature]

OFFICE OF TITLES

 DOCUMENT NOS E 817612 To E 817619
 YOUR REF. RELVIN NOM P/L & BEATY.
 DATE: 20/3/2023
REQUISITION NOTICE

Section 192 Of The Transfer Of Land Act

FIRST AND FINAL
ALL ENQUIRIES TO STOPPED DOCUMENT SECTION

 MARK BALFOUR & ASSOC
 SUITE 5, 24 RISELEY ST
 ADDRESS 6153

 N^o 2

& TO HAMMOND KING

REF. K20716 (HIT): JH: DF

REGISTRATION OF THE ABOVE DOCUMENTS CANNOT BE EFFECTED UNTIL THE REQUISITIONS LISTED BELOW ARE COMPLIED WITH:

- Unless these items are satisfied within 21 Days the Documents will be rejected and one half of the registration fee forfeited.
- Documents may be withdrawn from registration for which a fee will be retained. The balance of the fees will be refunded.
- Where a requisition fee is indicated the amount shown as the total is required to be paid before registration can proceed.

Doc. No.	Req. Fee.
618	\$
<i>If this document is dated on or after the 1st January 1992 then the company seal and sealing clause must show the Australian Company Number of Grantor N/A.A</i>	
<i>The duplicate of this deed is a photo copy (e.g. not signed) and as such is not acceptable</i>	
612, 614 & 616 (618)	\$
<i>All documents containing sketches must be produced to the survey advice officer, client services branch prior to lodgement of the document.</i>	
<i>Encement documents are only accepted in duplicate</i>	
Total \$ 120 20 \$60.00	



 D.L. MULCAHY
 REGISTRAR OF TITLES

 Telephone: (09) 222 6888 & 222 6833 • Fax (09) 222 6830
 'LAW CHAMBERS' CATHEDRAL SQUARE, PERTH • Postal Address: G.P.O. Box W2107, Perth, 6001

FILE COPY DO NOT DESTROY

FILE COPY DO NOT DESTROY

STOPPED CASE:— 817612

STOPPED DOCUMENT DISPOSAL INSTRUCTIONS

ORIG. Cs/T:—

Fees to be Refunded \$ _____

Form 10 No _____

Date ____/____/19____

To _____

Parties _____

Document Numbers _____

Computer Records Adjusted

NOTICE SENT:—

ACTION:—

Docs to be Withdrawn:—

Docs to be Rejected:—

Docs for Registration:—

Authorised by:—

EXAMINATION INSTRUCTIONS

Allocate New C/T

Complete Nom. Index

Pass To NT

Other _____

Examiner S. Crowe

Supervisor [Signature]



OFFICE OF TITLES

DOCUMENT NOS E 817612 TO E 817619

YOUR REF RELIN NOM P/L & BEATY.

DATE

ALL ENQUIRIES TO STOPPED DOCUMENT SECTION

MARK BALEOUR & ASSOC
SUITE 5, 24 RISELEY ST
ADDRESS 6153

REQUISITION NOTICE

Section 192 Of The Transfer Of Land Act

FIRST AND FINAL

Post

NO. 1.

& HAMMOND KING
REF K20716 (HIT): JH: DF

REGISTRATION OF THE ABOVE DOCUMENTS CANNOT BE EFFECTED UNTIL THE REQUISITIONS LISTED BELOW ARE COMPLIED WITH:

1. Unless these items are satisfied within 21 Days the Documents will be rejected and one half of the registration fee forfeited.
2. Documents may be withdrawn from registration for which a fee will be retained. The balance of the fees will be refunded.
3. Where a requisition fee is indicated the amount shown as the total is required to be paid before registration can proceed.

Doc. No.	Requisition	Req. Fee.
612	Encumbrances affecting the servient tenement must be shown in this document. OK ✓	
616	This deed must be dated Fixed @	\$
	Encumbrances affecting the servient tenement must be shown in this document.	Fixed @.
	If this document is dated on or after the 1 st January 1992 then the company seal and sealing clause must show the Australian Company Number of the Grantee.	\$ N/A dated December 91
618	This deed must be dated OK @	\$30 -
	Encumbrances affecting the servient tenement must be shown in this document. OK @	\$30 -
		Paid by H&K HAM & KING
		Total \$

D.L. Mulcahy
D.L. MULCAHY
REGISTRAR OF TITLES

ON 2nd SCHEDULE CONT'D 1502-185 (ORIG & DUP)

SKETCH
DRAFT SEE
TRANSFER

TRANSFER E 817612 . ~~TOGETHER WITH~~ A RIGHT OF SUPPORT
OVER THE PORTION OF THE WITHIN LAND MARKED 'A'
ON THE MAP IN THE MARGIN IS GRANTED TO THE
PROPRIETOR OR PROPRIETORS FOR THE TIME BEING OF LOT 500
ON DIAGRAM 60634 AS SET OUT IN AND DETERMINABLE BY
~~THE SAID~~ TRANSFER E 817612 . REGISTERED 26.2.92 AT 11:46

ON 1st SCHEDULE CONT'D 1598-353

NO SKETCH
TRANSFER E 817612 . A RIGHT OF SUPPORT OVER THE PORTION OF FREEMANTLE
TOWN LOT 441 COLOURED BLUE ON THE MAP IN TRANSFER E 817612
IS GRANTED TO THE PROPRIETOR OR PROPRIETORS FOR THE TIME
BEING OF THE WITHIN LAND AS SET OUT IN AND DETERMINABLE
BY THE SAID TRANSFER. REG. 26.2.92 AT 11:46



O168259 MH
10 Jun 2019 08:49:04 Perth



Memorial

Approved form 2017-98206 Reg 3 of the Transfer of Land Regulations 2004

The information in this form is collected under statutory authority and used for the purpose of maintaining publicly searchable registers and indexes.

Jurisdiction

State of Western Australia

Legislation

Transfer of Land Act 1893

Heritage of Western Australia Act 1990

Lodging party details

Name HERITAGE COUNCIL OF WA
Address 491 WELLINGTON STREET
PERTH WA 6000
Issuing box 888V
Phone 6552 4000
Fax 6552 4001
Email
Reference 25225

Preparer details

Name Mark Baker
Phone +61 8 6552 4083
Reference 25225

Memorial details

Act Heritage of Western Australia Act 1990
Section 56(1)
Ref No 25225

Statements An entry in respect to the above described land was made in the register of heritage places, pursuant to Division 2 of Part 5 of the Heritage of Western Australia Act 1990 and the particulars registered in respect of that entry are included herewith

Land / Interest

Title(volume-folio)	Extent	Land description	Interest
2510-203	Whole	LOT 19 ON STRATA PLAN 37612	FEE SIMPLE
2510-204	Whole	LOT 20 ON STRATA PLAN 37612	FEE SIMPLE

Registered proprietor(s) (Land)

WARREN JAMES IANNELLO OF 37 BARRINGTON STREET, MUNSTER

Authorising party

HERITAGE COUNCIL OF WA OF 491 WELLINGTON STREET PERTH WA 6000

Execution date

07/06/2019

Authorising party execution

Witness must be an adult person. The witness must state their full name, address and occupation.

Executed on behalf of HERITAGE COUNCIL OF WA under authority of the Heritage of Western Australia Act 1990

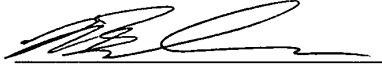
Witness signature 
Witness full name MARK COLIN BAKER
Witness address DEPARTMENT OF PLANNING
LANDS AND HERITAGE
Witness occupation SENIOR LAND INFORMATION OFFICER
Witness phone (08) 6552 4083

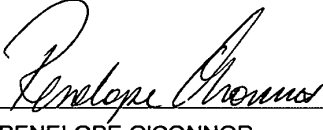
Signature 
Signer name PENELOPE O'CONNOR
Signer organisation DEPARTMENT OF PLANNING,
LANDS AND HERITAGE
Signer designation DIRECTOR, HERITAGE
ASSESSMENT AND
REGISTRATION



O174041 MH

18 Jun 2019 09:21:57 Perth



Memorial

Approved form 2017-98206 Reg 3 of the Transfer of Land Regulations 2004

The information in this form is collected under statutory authority and used for the purpose of maintaining publicly searchable registers and indexes.

Jurisdiction

State of Western Australia

Legislation

Transfer of Land Act 1893

Heritage of Western Australia Act 1990

Lodging party details

Name HERITAGE COUNCIL OF WA
Address 491 WELLINGTON STREET
PERTH WA 6000
Issuing box 888V
Phone 6552 4000
Fax 6552 4001
Email
Reference 25225

Preparer details

Name Mark Baker
Phone +61 8 6552 4185
Reference 25225

Memorial details

Act Heritage of Western Australia Act 1990
Section 56(1)
Ref No 25225

Statements An entry in respect to the above described land was made in the register of heritage places, pursuant to Division 2 of Part 5 of the Heritage of Western Australia Act 1990 and the particulars registered in respect of that entry are included herewith

Land / Interest

Title(volume-folio)	Extent	Land description	Interest
SP37612	Part	COMMON PROPERTY	FEE SIMPLE

Registered proprietor(s) (Land)

OWNERS OF PAKENHAM APARTMENTS OF STRATA PLAN 37612, 56 PARKENHAM STREET (CNR OF NAIRN STREET) FREMANTLE 6160

Authorising party

HERITAGE COUNCIL OF WA OF 491 WELLINGTON STREET PERTH WA 6000

Execution date

07/06/2019

f1ee6c92-3f12-4d34-bf58-d1706e641e68

Page 1 of 2

Authorising party execution

Witness must be an adult person. The witness must state their full name, address and occupation.

Executed on behalf of HERITAGE COUNCIL OF WA under authority of the Heritage of Western Australia Act 1990

Witness signature 
Witness full name MARK COLIN BAKER
Witness address DEPARTMENT OF PLANNING
LANDS AND HERITAGE
Witness occupation SENIOR LAND INFORMATION OFFICER
Witness phone (08) 6552 4083

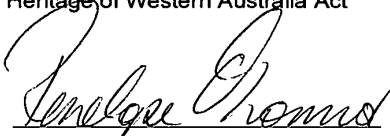
Signature 
Signer name PENELOPE O'CONNOR
Signer organisation DEPARTMENT OF PLANNING,
LANDS AND HERITAGE
Signer designation DIRECTOR, HERITAGE
ASSESSMENT AND
REGISTRATION

Anstey, Harry Louis Richards	Brown, Jillian
Arthur, Kimberley John	Browne, Edmund Gerard
Atcheson, Karen Eileen	Browne, Janine Elizabeth
Atherton, Lynda	Bull, Geoffrey John
Atkins, Lizzette Jewell	Bull, Jennifer
Atwell, Rosemary Elizabeth Ann	Bunney, Rose Louise
Atwell, Steven John	Butcher, Hayley Debra
Baddeley, Richard Hiram	Campbell, William Alexander
Bafile, Paolo	Capozzi, Jennifer Maree
Bafile, Zelinda	Capozzi, Nicola
Bailey, Andrew Charles	Capozzi, Peter
Bain, Simon John	Caratti, Francis Victor
Baker, Mary	Caratti, Michael John
Bale, Matthew James	Carr, Catherine Mary
Banham, Caroline Mary	Cattalini, Pamela Rae
Banham, Francesca Maria Concetta	Cetinic, Anton
Barker, Jessie Margaret Graham	Cetinic, Snjezana
Barker, Michelle Ann	Chiovitti, Anna Maria
Barker, Simon Timothy	Chorlton, Paul David
Bartlett, Richard Hamilton	Christie, Michael Joseph
Barton, Simon Freer	Christie, Nancy Elizabeth
Bateman, Christine Lee	Ciccarelli, Carl William
Batista, Aparecida Campos Dell'Orto	Ciccarelli, Mary Elizabeth
Baws, Nathan	Ciganek, John
Baws, Rachel	Ciganek, Rebel Helen
Bebbington, Pamela May	Cimenbicer, Cigdem
Bebbington, Peter Michael Harold	Cinanni, Katrina Anne
Belford, Susan Margaret	Civitella, Mark Jason
Benjamin, Ann	Clayton, Alan Stuart
Biggs, Paul Hadyn	Clune, Peter John
Biondillo, Maria Carmina	Clune, Vera Kate
Blaasch, Narelle Margaret	Cochrane, Jennifer Anne
Blank, Leanda Maree	Coffey, David Patrick
Blank, Roland Alios	Collins, Mark Francis
Blick, Steven Gary	Collins, Victoria Albertina
Boddington, Aaron Bruce	Cooney, Julian Patrick
Boddington, Deborah Jane	Cooney, Sheila Angela
Bourke, Anthony Mary	Cunnold, Leanne Margaret
Bourke, John Francis	Curphey, Iain John
Bourke, Michael Joseph	Da Silva Cipriano, Agostinho
Braddock, Shane Lisle	Da Silva Cipriano, Anna
Brett, Neil Allan	Dallas, Fiona Cameron
Brett, Tracey Leanne	Darbyshire, Andrew Roy
Brophy, Benjamin John	Davidson, Clare Hazel Rose Isobel

Davies, Michael William
De Bruyn, Nicole Suzanne Lobry
De Koning, Nico
De Souza, Samuel Marc
Del Popolo, Gaetano Anthony
Del Popolo, Melissa Gay
Della Seta, Alessandra
Di Nunzio, Luca Carmino
Di Nunzio, Margaret Joy
Dixon, Brodie Alexander
Doogan, Frances
Doogan, James Gerrard
Dowson, John Howard
Drexel, Heather
Duddy, Carol Anne
Duddy, Peter O'Neil Heron
Dudney, Gianna Sonia
Dudney, Paul
Dwyer, Peter Andrew James
Eccles, Helen Mary
Ednie-Brown, Antony Colin
Edwards, Kathleen Doris
Ellery, Bruce Richard
Elphick, Kenneth Clifton
Elphick, Mary Rose
Endersby, Anita Faye
Endersby, David Craig
Esmonde, Pamela Mary
Everett, Michael John
Every, Anthony John
Fairfax, Jacqueline Angela
Fairhead, Anthony Peter
Fairhead, Roslynn Joy
Feillias, Nyuk Kong
Feillias, Renaud Jean Philippe
Fine, Hilary Jayne
Finn, Eleni George
Finn, Michael Boyd
Flood, Gillian Paula
Flood, Thomas John
Forth, Simon Craig
Gabbedy, Doris Jean
Gabbedy, John Charles
Galati-Rando, Antonina Rosaria

Galati-Rando, Antonino
Galvagno, Carmelo Basil
Garbutt, Lauren
Gardiner, Gilbert Irving
Gardiner, Wendy Anne
Garner, Amanda Kaye
Giang, Man Chi
Giangiordano, Eduardo
Giangiordano, Michele
Gibbs, Aileen Sarah Harding
Giddens, Warren Ivan
Gillett, John Frederic Martin
Gliddon, Anne Naria
Gliddon, John Trafford
Goellnicht, Peter Nicholas
Goodridge, Damian Mark
Goodwin, Christine Frances
Goodwin, Edward
Gould, David
Greco, Antonietta Maria
Green, Russell Jay
Green, Shirley Anne
Grisewood, Marianne Irene
Grisewood, Walter Charles
Hagan, Jacqueline Mary
Hannell, John Edwin
Hare, Colette Janetta
Harper, Hsien
Harrison, Robert John
Harsley, Kathryn Ann
Harsley, Matthew Victor
Haultain, Annie Garden
Heagney, Margaret
Heagney, Michael Albert
Heenan, Kevin John
Henley, Keith
Henwood, Colyn Marie
Hewitt, Helen Maude
Hewitt, Robert Peter
Hicks, Stuart Keith
Hicks, Suzanne Louise
Hill, Christina Ruth
Hill, Julianne Rosalie
Hill, Roland James

Hill, William Kerry
Hoerdemann, Mona
Holst, Dianne Patricia
Holst, Glen Mervyn
Horgan, Christian
Horgan, Patricia Anne
Hulett, Kate Jane
Hulse, Gary Kenneth
Hunt, Grant
Iannello, Warren James
Ingham, Frank
Jacob, Jessy
Jacob, Ollapallil Jacob
James, Ian Malcolm
James, Shelley
Janmaat, Jan David
John, Suzanne Grayson
Johnson, Kathleen Margaret
Johnson, Wayne
Johnston, Kelsie-Ann
Jones, Brendan Martin Cecil
Jones, Jane Elizabeth
Jones, Matthew David
Jury, Brian Edmund
Kanganas, Agapitos Nicholas
Kanganas, Ethel Agnes
Kanganas, Panagiotis Agapitos
Kanganas, Rose
Katnich, Bradley John
Kelly, Caitlin Shaunagh
Kempthorne, Brian Charles
Kempthorne, Joan Anne
Kennedy, Christopher James
King, Christine Joan
King, Ronald Charles
Kirwan, Elizabeth Anne
Kong-Yit, Lily
Koning, Franciscus Johannes
Kouzinias, Damianos
Kouzinias, Helen
Kouzinias, Thomas
Kouzinias, Vasilios
Kovacevic, Boban
Kroeber, Gregory Charles

Ladyman, Sara Frances
Lapedota, Roberto
Larwood, June Alison
Laurenson, Natalina Maria
Lawrence, Leonard Francis
Lawson, Sarah
Leach, Juliette Rachel
Lee, Say Tong
Lenthall, John Harry
Lenzo, Alberina
Lenzo, Vincenzo
Lewis, Joan
Li, Aoning
Lim, See Bee
Line, Simon James
Line, Wendy Jayne
Lithgo, Betty
Lockhart, Colin William
London, Geoffrey Leslie
London, Joan Elizabeth
Lopez, Cheryl Eileen
Lopez, George Aubrey
Lucioli, Alessandro
Lyons, Christopher Jack
Macgibbon, Wendy Josephine
Maclaren, Jacob Llyall
Maclaren, Lynn Ellen
Macri, Antonino
Macri, Giuseppe
Magistro, Maria
Maguire, Edward Charles
Malcolm, Sally-Lyn
Malhotra, Rikshesh
Marra, Mario Fausto
Marra, Silvia
Marshall, Jann
Martin, John David
Martin, Kellie Lorraine
Mascaro, Anthony Lloyd
Matsen, Charles Roswald Ophir
Matsen, Eleanor Mary
McCann, Gerard Francis
McKee, Kim Louise
McLeod-Thorpe, Glen Vernon

Mehan, Richard Russell	Noble, Anne Marie
Merlino, Giuseppe Adelio	O'Byrne, Robyn Annette
Miles, Ronald Charles	O'Byrne, Rodney Clayton
Miles, Stephanie Amy	O'Connor, Elizabeth Ann
Miller, John James	O'Connor, Terence Edward
Miller, Kay	O'Daly, Kevin James
Mitchelmore, Mark	Odfeldt, Inge Margrethe
Molnar-Darbyshire, Barbara Bianca	Odfeldt, Joergen
Moltoni, Glen David	O'Halloran, Gail Maree
Moltoni, Harmony Catherine	O'Halloran, Michael Francis
Monaco, Gino	Olney, Harriet Rose
Monaco, Paul Christopher	O'Lone, Ada Heather
Monro, Duncan Stewart Shaw	O'Lone, James
Moore, Colin Phillip	O'Neill, James Francis
Moore, George Frederick	O'Neill, Suzanne Mary
Moore, Jacqueline Ann	Oostryck, Frederik
Moore, Samuel Joseph Fortescue	Oostryck, Marlene Mary
Moore, William Dalgety	Orlando, Giuseppe
Morgan, Anne Elizabeth	Orlando, Patricia Betty
Morgan, Graham Ronald	Osborn, Catherine Louise
Morgan, Peter William	Ow, Julie Lum Peng
Morgan, Timothy Hop	Owen, Janette Mary
Morris, Christine Anne	Owen, John Raymond
Morse-Evans, Daryl	Page, Susan Jean Michele
Morse-Evans, Helen	Palassis, Ariane
Mortimer, James Francis	Pam, Maxwell Rodney
Mossenson, Dan	Parker, David Charles
Mossenson, Diane Susan	Paton, David James William
Mousli, Abdul Majied	Patroni, Michael Brian
Murphy, Catherine Mary	Paull, Albert John
Murphy, Charles Denys	Paull, Brett Albert
Murphy, Margaret Mary	Paull, Margaret Jean
Musto, Kenneth William	Paull, Mark Andrew
Musto, Lynette Jean	Paull, Rachel Louise
Narvaez, Antonio	Payne, Judith Mary
Nasuti, Angela	Pearson, Kathryn Ann
Nasuti, Joseph	Peter, Duncan
Nazroo, Anne Helene	Peter, June
Nazroo, Michael Fuad	Peter, Norman
Nelson, Michael Charles	Phegan, Eugenia Benchimol Xavier
Nicholas, Gillian Susan	Phegan, Scott Keith
Nicholas, Ian James	Phillips, Kevin Maxwell
Nicholson, Adam John George	Phillips, Tracey Ann
Nield, Linda Karen	Philpott, Rodger Frank

Philpott, Susan Jean
Piscioneri, Armando
Polimeno, Fernando
Polimeno, Giuseppe
Polimeno, Giuseppina
Polimeno, Salvatore
Polinelli, John Anthony
Porter, Linda Patricia
Poulson, Kylie-Jane
Poulson, Richard James Charles
Provis, Belinda Ann
Pruiti, Sarina
Puca, Lorraine
Puca, Marco
Punchard, Edwin Thomas Richard
Quackenbush, Dawn Elizabeth
Quackenbush, Mark Victor
Quarrill, Jace Anthony
Quigley, Allan James
Quirici, Luisa
Quirici, Michael
Radonich, Jason Paul
Radonich, Stephanie Margaret
Raggat, Paul Alan
Rankin, John Kenneth
Raynes, Jacqueline Maree
Reed, Clara
Ricciardi, Calogero Paul
Ricciardi, Ignazio Peter
Ricciardi, Silvana
Ricciardi, Sylvia Maria
Rimes, Matthew James
Robb, Andrew Coyne
Rooney, Kim Margaret
Rosman, Danielle Christina
Rosman, Diana Lyle
Rosman, Johanna Heidi
Ross, Craig Steven
Rotondella, Michael
Ruane, Teresa Anne
Rumley, Dennis
Rumley, Hilary Eileen
Ryan, Anthony Paul
Ryan, Kathleen Delma

Saccone, Lorenzina Maria Lucia
Saccone, Vincenzo Paolo
Sayer, David Charles
Schairer, Helene Rose
Schmitz, Elizabeth Rosamond
Schram, Maureen Joy
Scudds, Jeremy James
Scudds, Sutherland James Chevron
Sells, John Calvin
Simpson, Flora
Stacey, Frances Bedelia
Stacey, Richard William
Stammers, Wayne Joseph
Staniforth, Karen
Steed, Sarah Kate
Stevens, Philip John
Stevenson, Emma Jane
Stoiber, Christine
Sutton, Ashley Robert
Tatham, Sandy
Taylor, Antony Conio
Taylor, Catherine Mary
Taylor, Kaylene Dawn
Temby, Cameron James
Thomas, Anne
Thomas, Gareth Huw
Thornton, Robert George
Thorpe, Vernon Hugh
Timperio, Cassandra Olivia
Timperio, Isti
Tomazos, Evdokia
Tomeo, Angela
Tomeo, Michele
Tracy, Ann Lynette
Trainer, Jeanne Stoddart
Trevelyan, Jolin Anne
Triscari, Antonino
Triscari, Giuliana
Tyson, Francis Henry
Vakil, Adil Eruch
Vakil, Khushnood Adil
Van Anderson, Scott
Van Der Merwe, Mathys Jacobus
Van Der Wiele, Michael John

Vickridge, Velma Elizabeth
Walton, Peter Kenneth
Warburton, Oliver David
Warren, Nancy Evelyn
Warwick, Amanda Jane
Warwick, Roy William
Watson, Charles Roger Rolleston
Watt, Tanya Rochelle
Weggelaar, Brett Leonard
Wheeler, Carl William
Wheeler, Lucy Yan Xu
Whitley, Christopher Edward
Whitley, Timothy Peter
Wilkie, Christine
Williams, Piers Brooke
Williams, Wayne Mark
Wilson, Darran John William

Private Companies

7/33 Pakenham Pty Ltd
Affinity Holdings Pty Ltd
Amelia Correia Holdings Pty Ltd
Artecasa Pty Ltd
Avion Nominees Pty Ltd
BK Investments Australia Pty Ltd
Brisam Holdings Pty Ltd
Calista Pty Ltd
Camisa Nominees Pty Ltd
Carnegie's Realty Pty Ltd
CBD Rev Holdco Pty Ltd
CM & KE Nominees Pty Ltd
Colama Pty Ltd
Correct Weight International Pty Ltd
Daniele Nominees Pty Ltd
Debretton Pty Ltd
Dorado Yolk No 3 Pty Ltd
Dunross Enterprises Pty Ltd
Dural Holdings Pty Ltd
Dwm Super Pty Ltd
East Burn Nominees Pty Ltd
Eco Beach Pty Ltd
Edmund Rice Centre Ltd
Epping Forest Pty Ltd
Esselton Pty Ltd
Fabray Pty Ltd

Wilson, John Lawrence
Wilson, Keith Murray
Wilson, Michael Brett
Wilson, Suzanne Michelle
Windram, Scott Alan
Withers, Debbie Kaye
Withers, William Robert
Wong, Lap Ching
Wright, Elizabeth Ann
Yit, Alan Tsong Hong
Zagami, Jemal David
Zaky, Fekry Fathy
Zaky, Souzan
Zanki, Ivanica
Zonato, Gabrielle Carmela
Zucaro, Iain Jeffrey

FC Cook & Co Pty Ltd
Fineblend Investments Pty Ltd
Franknelly Nominees Pty Ltd
Freeland Investments Aust Pty Ltd
Galeforce Fisheries Pty Ltd
Geroheev Pty Ltd
Gilderoy Pty Ltd
Global Consolidated Investments Pty Ltd
Grakin Pty Ltd
Grande Developments Pty Ltd
GW & KJ Johnston Pty Ltd
Hamlet Properties Pty Ltd
Henry St Pty Ltd
Henry Street Project Pty Ltd
Horn Holdings Pty Ltd
I Timperio Pty Ltd
Jacaranda Management Pty Ltd
Jansil Pty Ltd
Jericho Exploration Pty Ltd
Khamsin Nominees Pty Ltd
Kybee Pty Ltd
Leibniz Investments Pty Ltd
Macadamia Nominees Pty Ltd
Manton Enterprises Pty Ltd
Mazara Pty Ltd
Mediterranean Shipping Co Aust Pty Ltd

Register of Heritage Places
West End, Fremantle
18 July 2017

7

MG Constructions Pty Ltd
 Milhill Pty Ltd
 Monk Nominees Pty Ltd
 Monson Agencies Australia Pty Ltd
 Mouat Street Pty Ltd
 Nandi Valley Pty Ltd
 NG Photos Pty Ltd
 Ortana Pty Ltd
 P&D Civil & Structural Engineering Pty Ltd
 Pearl River Pty Ltd
 Pecan Nominees Pty Ltd
 Peterborough Nominees Pty Ltd
 Portshine Pty Ltd
 Rainbow Castle Pty Ltd
 Red Rock Consolidated Pty Ltd
 Regal Light Pty Ltd
 Rely Investments Pty Ltd
 Rivington Holdings Pty Ltd
 Rongal Investments Pty Ltd
 Roseville Corporation Pty Ltd
 Rospec Pty Ltd
 Ruby Lane Pty Ltd
 Rygold Nominees Pty Ltd
 Salvemini Holdings Pty Ltd
 Saprowe Pty Ltd
 Scope Property Group Pty Ltd

Other Organisations

Australian Maritime Officers Union
 Fremantle Buffalo Club Inc
 Fremantle Chamber of Commerce Inc
 Lance Holt Schools Council Inc
 Navy Club Inc

State Government

State of Western Australia

Responsible Agencies:

Management Orders:

Department of Planning, Lands and Heritage; Public Transport Authority; Western Power, Department of Local Government, Sport and Cultural Industries; WA Museum; FES Ministerial Body; Department of Communities

City of Fremantle; Public Transport Authority; Western Power; Minister for Culture and the Arts; WA Museum

Second Empire Pty Ltd
 Shividella Ltd
 Silkshore Holdings Pty Ltd
 Silverleaf Investments Pty Ltd
 Sirona Capital Management Pty Ltd
 Siroqueone Pty Ltd
 SJB Town Planners Pty Ltd
 Springbank Nominees Pty Ltd
 SRMS Holdings Pty Ltd
 Talltree Holdings Pty Ltd
 Thornwood Nominees Pty Ltd
 Tiaki Pty Ltd
 Tintedoils Pty Ltd
 Total Meat Exports Pty Ltd
 Trafalgar Investments Pty Ltd
 Vezzi Nominees Pty Ltd
 Violet Investments Pty Ltd
 Wallis Enterprises Pty Ltd
 Waterford Nominees Pty Ltd
 Watermark Asset Pty Ltd
 Wellgood Holdings Pty Ltd
 Westblock Services Pty Ltd
 Whincup Super Pty Ltd
 WHJ Samson Pty Ltd
 Wigcorp Pty Ltd
 Wingfield Pty Ltd

Church

Roman Catholic Archbishop of Perth

University

University Of Notre Dame Australia

Local Government

City of Fremantle

7. HERITAGE LISTINGS

**Register of Heritage Places
 West End, Fremantle
 18 July 2017**

• Register of Heritage Places:	Interim	18/11/2016
	Permanent	18/07/2017
<i>Individual Places:</i>		
P00857 Commissariat Buildings (fmr)	Permanent	22/06/2001
P00951 Fremantle Post Office	Permanent	09/02/1996
P00915 Union Stores Building (fmr)	Permanent	09/11/1993
P00958 Tarantella Nightclub (fmr)	Permanent	08/10/1996
P00946 Court House (fmr)	Permanent	28/11/2003
P00963 Strelitz Buildings	Permanent	11/10/1994
P00977 Customs House (fmr)	Permanent	23/04/1999
P00945 Water Police Station & Quarters (fmr)	Permanent	10/06/1994
P00982 Fremantle Fire Station (fmr No.2)	Permanent	16/11/1993
P00889 Fowler's Warehouse (fmr)	Permanent	09/11/1993
P00980 Chamber of Commerce Building	Permanent	16/03/2001
P00914 Orient Hotel	Permanent	02/09/1997
P00981 P & O Building	Permanent	09/05/1997
P00882 Lance Holt School	Permanent	23/11/2004
P00975 His Majesty's Hotel	Permanent	05/11/1999
P00859 Lilly's Buildings	Permanent	18/02/2005
P00959 Adelaide Steamship House (fmr)	Permanent	28/08/2001
P00906 Bank of Australasia (fmr)	Permanent	02/06/1995
P00854 Wilhelmsen House	Permanent	23/06/2000
P18772 Warehouse, 22-26 Pakenham St	Permanent	04/05/2012
P00892 Warehouse (fmr), 52 Henry St	Permanent	19/11/1993
P00890 Moore's Building	Permanent	29/10/1993
• National Trust Classification:	Classified	29/01/1980
• Town Planning Scheme:		-----
• Municipal Inventory:	Adopted	14/10/2000
• Register of the National Estate:	Permanent	29/09/1981

8. ORDERS UNDER SECTION 38 OR 59 OF THE ACT

9. HERITAGE AGREEMENT

10. STATEMENT OF SIGNIFICANCE

West End, Fremantle, bounded by Market Street to the east, Collie Street and Marine Terrace to the south, Little High Street to the west and Phillimore Street to the north, and including the lots on the northern side of Phillimore Street between Cliff and Henry Streets, has cultural heritage significance for the following reasons:

the place is rare in Western Australia as a highly intact port city business district, retaining a range of buildings predominantly dating from the gold boom expansion era (1890s-1900s), along with some evidence of earlier and later periods, that retains an ongoing connection with maritime industries;

the place is characterised by a very fine collection of predominantly Federation era buildings in a variety of classically-influenced styles, many of which retain substantial original features, which together form a cohesive precinct featuring common detailing, scaling, siting, construction

materials and historical functions, and includes many individually significant buildings;

the place has been associated with Fremantle's maritime operations from 1829 to the present and, through the range of premises in the precinct, demonstrates the operations of a port city including banks, customs, import and export businesses, ship-related trades, policing, prostitution, accommodation, unions and migrant services;

the development of the place was in response to the opening of the inner harbour in 1897, which reoriented the West End towards its northern face, established Fremantle as the State's main port and saw an increase in the size and number of shipping companies operating out of the area, and its twentieth-century economic decline was a result of modernisation and northern expansion of the port in the 1950s and 1960s;

in its built fabric, the place, particularly the imposing or opulent buildings and streetscapes of the 1890s and 1900s, the precinct demonstrates the impact of the Gold Boom period on the State, when money and population flooded into the Colony, and Fremantle became a flourishing, prosperous port town;

the place policed, and was partially constructed by convicts and is intrinsically linked with the nineteenth century convict history of Western Australia;

the port associated with the place was the main arrival point for migrants to Western Australia from 1829 until the second half of the twentieth century, and the place was a major part of their first experience of the State;

the place is a landmark area defining the western end of Fremantle, with strong entry statement buildings at several points, views to and from Fremantle landmarks and, historically, views from the sea;

the archaeology of the place has a high degree of potential to reveal information about the history and occupation of the West End from 1829 to the present, particularly with regard to deposits dating to the pre-Gold Rush era;

the place was rejuvenated in the mid-1980s as part of preparations for hosting the America's Cup yachting event in 1987, which brought international attention to Fremantle;

the place is associated with many significant individuals, including government and private architects, merchants and other business people of the area, union leaders, former residents and the original surveyor, John Septimus Roe, whose 1830s plans for the town continue to dictate the precinct's road layout and lot boundaries; and,

the place is significant to the local community as an historic area that contributes to the community's sense of place, as evidenced by the work of the Fremantle Society since 1972 to protect and restore the precinct, and is representative of the role of community activism in protecting and restoring many heritage sites in Western Australia prior to the introduction of heritage legislation in 1990.



STATE
HERITAGE
OFFICE

491 Wellington Street, Perth WA 6000
Tel: (08) 6552 4083 Fax: (08) 6552 4001
Email: mark.baker@dph.wa.gov.au
www.stateheritage.wa.gov.au

TO: Dealings, LANDGATE
FROM: Mark Baker
Land Information Officer
Email: mark.baker@dph.wa.gov.au
DATE: 15 July 2019

YOUR REF: O174028, O174032, O174035, O174038, O174039, O174040, O174043, O174044, O174045, O174048.

OUR REF: P25225

In relation to Document:

O174028

I can confirm that the intention of the Memorials is to be lodged over the "WHOLE" of the Common Property.

Also can I please have the below documents Scheme amended to reflect the below ownerships.

Document No.'s;

O174028 –
'The Owners of 32 Henry Street Fremantle WA Strata Plan No. 52482'
O174032 –
'The owners of Established Strata Plan Number SP69606'
O174035 –
'The owners of 48 Henry Street Fremantle Strata Plan Number 57006'
O174038 –
'The owners of 26 Marine Terrace Fremantle Strata Plan Number 45246'
O174039 –
'The owners of 34 Pakenham Street Fremantle Strata Plan Number 43943'
O174040 –
'The Owners of 14, 16, 18 & 20 Nairn Street Fremantle Strata Plan No. 4126'
O174042 –
'The owners of 93-95 High Street Fremantle Strata Plan Number 32624'
O174043 –
'The owners of 10-12 Phillimore Street Fremantle Strata Plan Number 32778'
O174044 –
'The owners of 29 Henry Street Fremantle Strata Plan Number SP33209'
O174045 –
'The owners of 49 Pakenham Street Fremantle Strata Plan Number SP29732'
O174048 –
'The owners of 5 Mouat Street Fremantle Strata Plan Number 25827'

Kind regards,

Mark Baker | Senior Land Information Officer | Heritage Services
Bairds Building Level 3, 491 Wellington Street, Perth WA 6000
ph: 6552 4083
mark.baker@dph.wa.gov.au | www.dph.wa.gov.au.

FORM B 4

FORM APPROVED
NO. B1520

H 435767 SM
 04 May, 2000 09:56:24 Perth

 REG. \$ 66.00

LODGED BY **ANDERSON SMITH CONSULTING**
 ADDRESS **PO BOX 646 WEST PERTH 6872**
 PHONE No. **92263000**
 FAX No. **92263317**
 REFERENCE No. **586**
 ISSUING BOX No. **262**

PREPARED BY
 ADDRESS
 PHONE No. FAX No.

INSTRUCT IF ANY DOCUMENTS ARE TO ISSUE TO OTHER THAN LODGING PARTY.



TITLES, LEASES, DECLARATIONS ETC. LODGED HEREWITH

1.	_____	Received Items
2.	_____	Nos.
3.	_____	
4.	_____	
5.	_____	
6.	_____	Receiving Clerk

Handwritten signature 'JY' in the Receiving Clerk field.

Registered pursuant to the provisions of the TRANSFER OF LAND ACT 1893 as amended on the day and time shown above and particulars entered in the Register.

EXAMINED

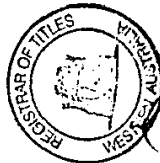

LP3141 (URGENT)

FIRST FLOOR PLAN 1:100

- COMMON WALL
- UNIT WALL
- UNIT WALL - EXTERIOR WALL
- UNIT WALL - INTERIOR WALL
- UNIT WALL - EXTERIOR WALL - WITH GLAZING
- UNIT WALL - INTERIOR WALL - WITH GLAZING
- UNIT WALL - EXTERIOR WALL - WITH GLAZING - WITH CURTAIN WALL
- UNIT WALL - INTERIOR WALL - WITH GLAZING - WITH CURTAIN WALL

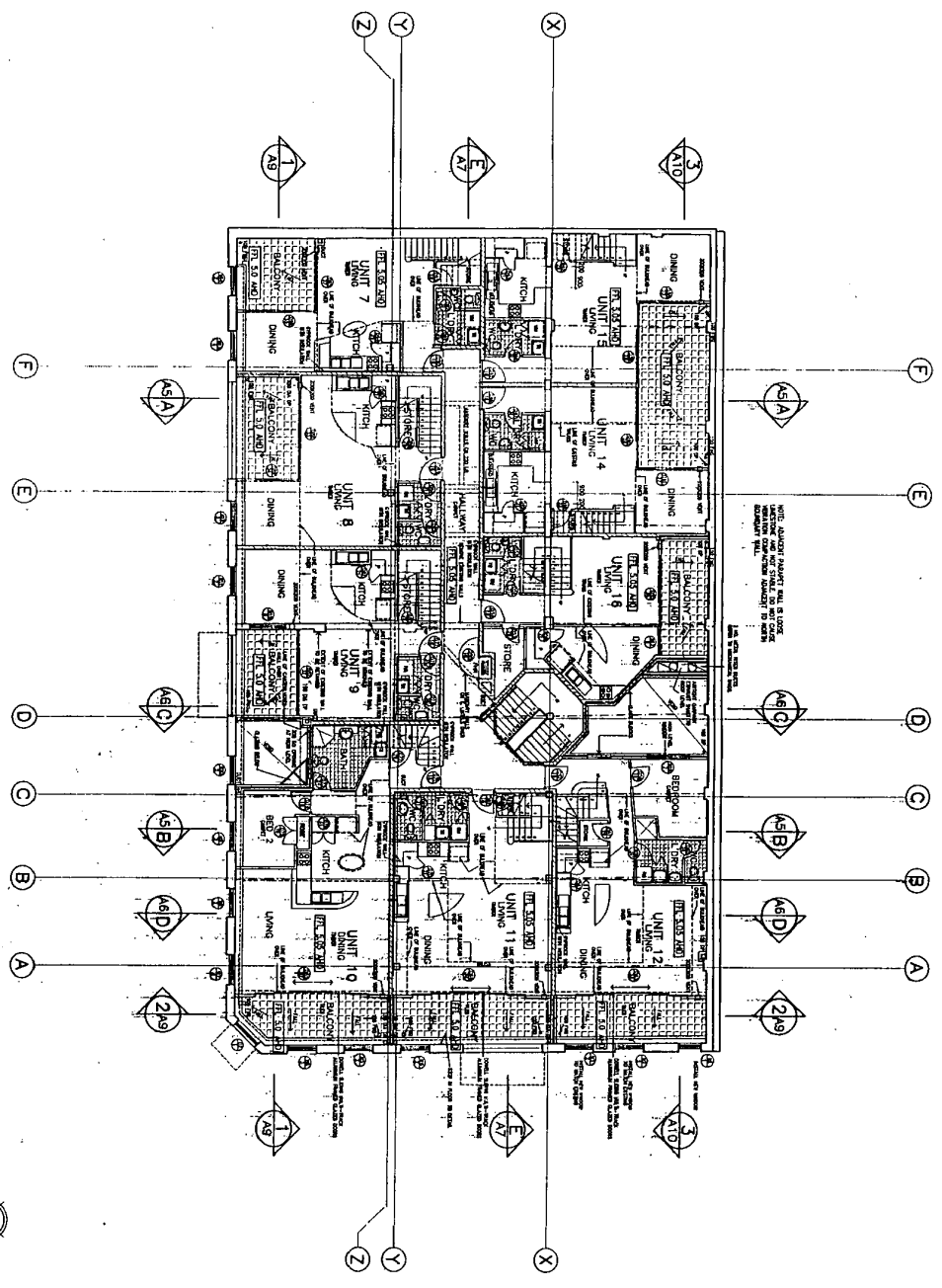

NOTE: UNITS WITH GLAZING WALLS OR GLAZING WALLS WITH CURTAIN WALLS TO BE OPENED UP TO SUITS



PHILIP MCALLISTER ARCHITECTS 100/102 WILSON STREET PERTH WA 6000 PH: 08 9438 1111 FAX: 08 9438 1112 WWW.PHILIPMCALLISTER.COM.AU		PROJECT NO. 2022/0000000 DRAWING NO. AD21 DATE 25/08/2023
PHILIP MCALLISTER ARCHITECTS 100/102 WILSON STREET PERTH WA 6000 PH: 08 9438 1111 FAX: 08 9438 1112 WWW.PHILIPMCALLISTER.COM.AU		PROJECT NO. 2022/0000000 DRAWING NO. AD21 DATE 25/08/2023
PHILIP MCALLISTER ARCHITECTS 100/102 WILSON STREET PERTH WA 6000 PH: 08 9438 1111 FAX: 08 9438 1112 WWW.PHILIPMCALLISTER.COM.AU		PROJECT NO. 2022/0000000 DRAWING NO. AD21 DATE 25/08/2023

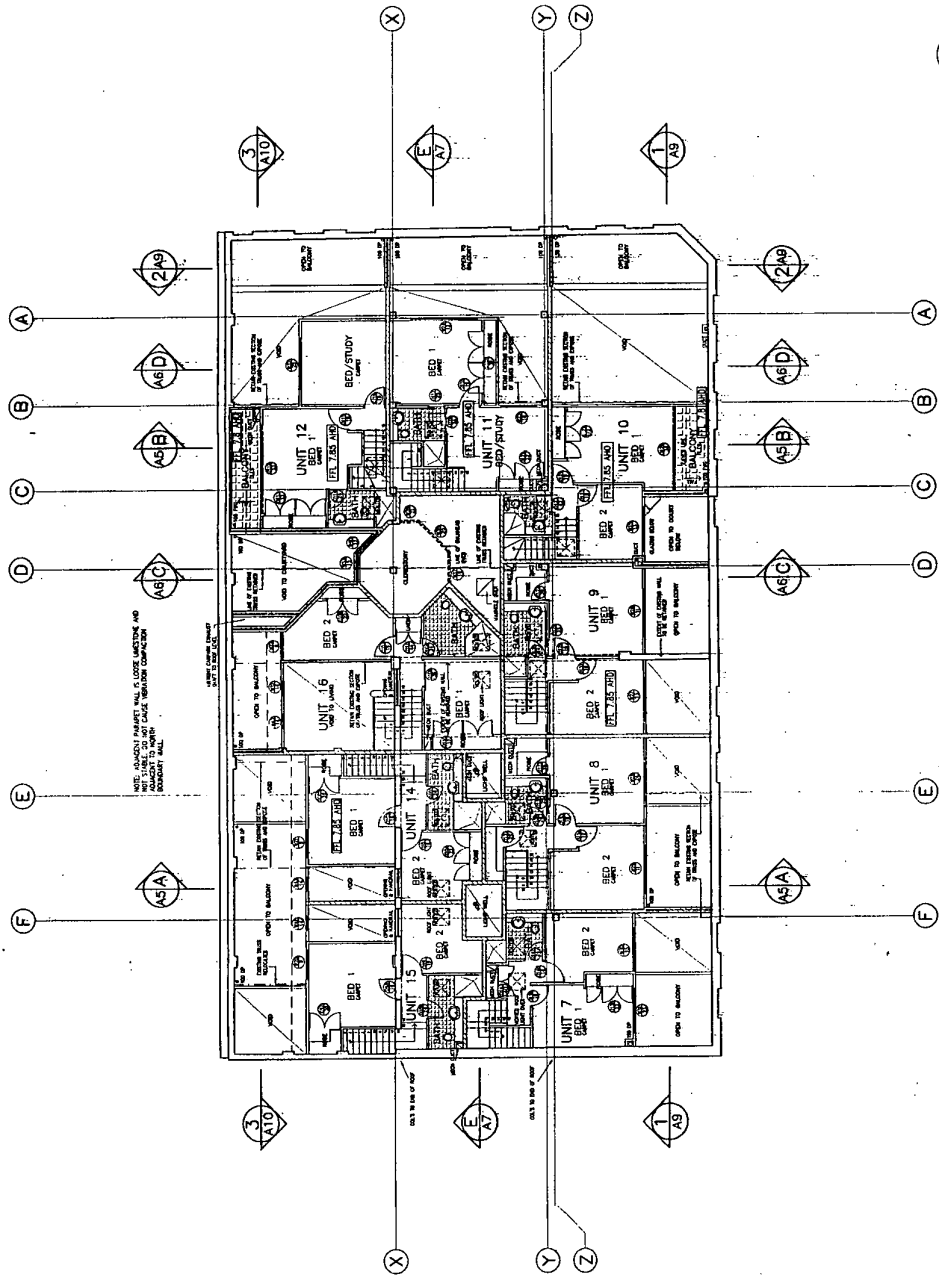

MEZZANINE FLOOR PLAN 1:100

- COMMON WALL
- 100mm CONCRETE WALL
- 200mm CONCRETE WALL
- 300mm CONCRETE WALL
- 400mm CONCRETE WALL
- 500mm CONCRETE WALL
- 600mm CONCRETE WALL
- 700mm CONCRETE WALL
- 800mm CONCRETE WALL
- 900mm CONCRETE WALL
- 1000mm CONCRETE WALL
- 1100mm CONCRETE WALL
- 1200mm CONCRETE WALL
- 1300mm CONCRETE WALL
- 1400mm CONCRETE WALL
- 1500mm CONCRETE WALL
- 1600mm CONCRETE WALL
- 1700mm CONCRETE WALL
- 1800mm CONCRETE WALL
- 1900mm CONCRETE WALL
- 2000mm CONCRETE WALL

KITCHEN PLANS AND ELEVATIONS
SCALE 1:50

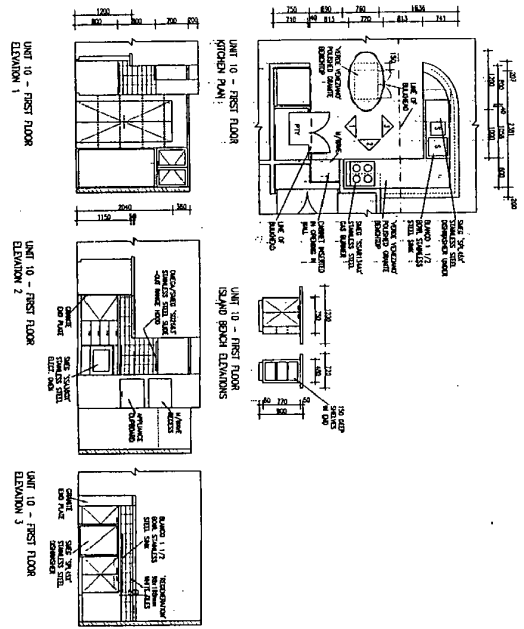
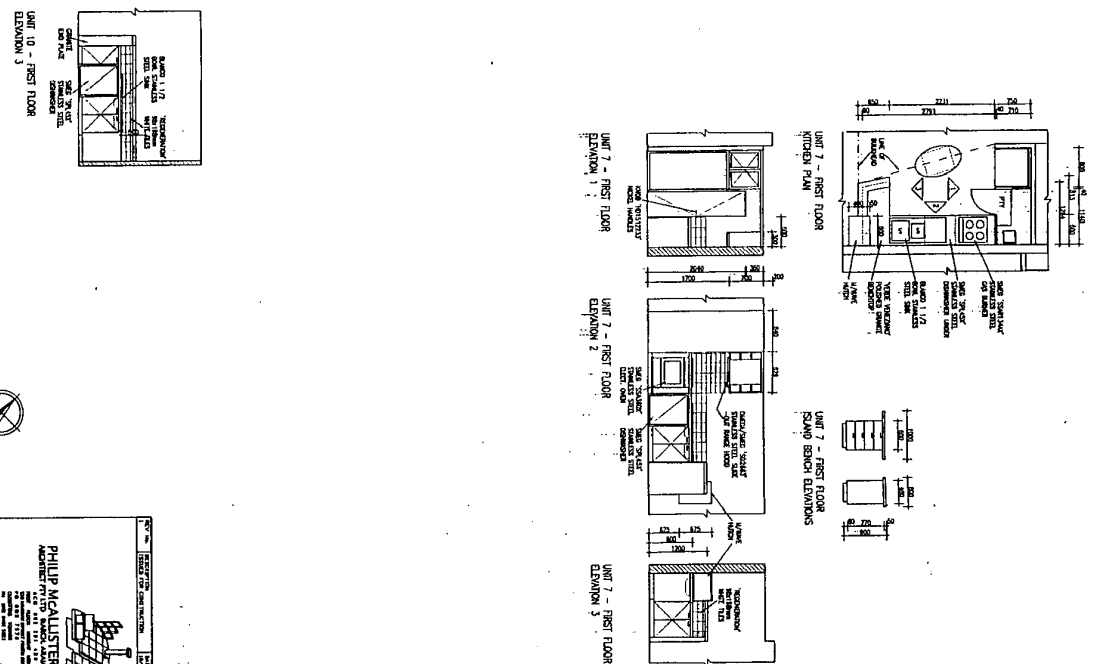
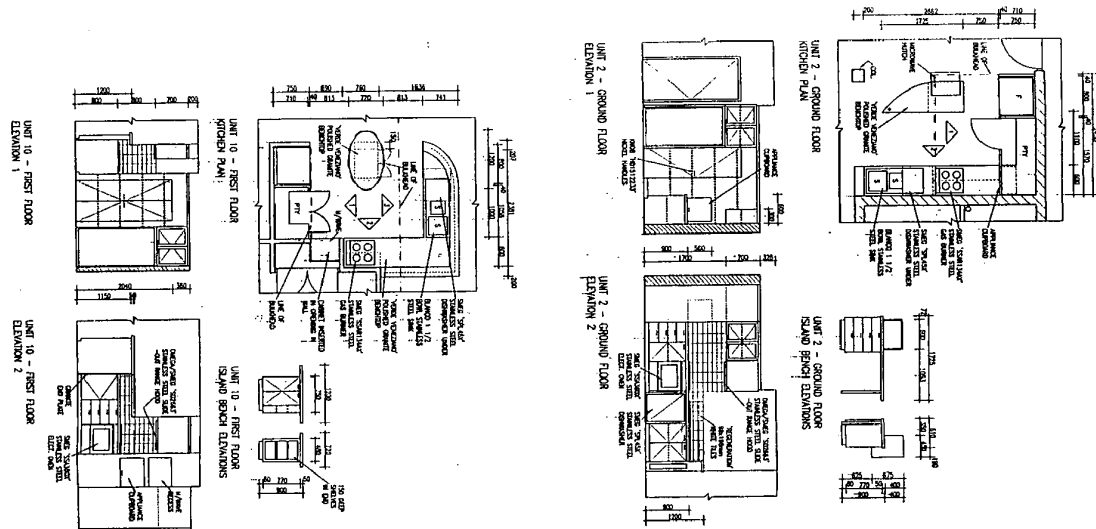
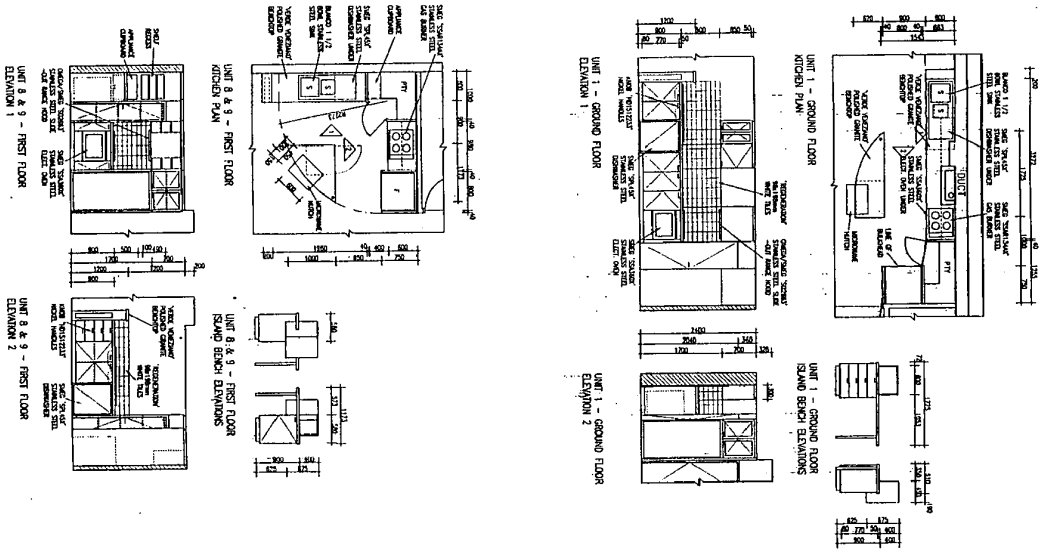

<p>PHILIP MCMASTER ARCHITECT</p> <p>10/100 WILSON STREET PERTH WA 6000</p> <p>PH: 08 9442 1111 F: 08 9442 1112 WWW.PHILIPMCMASTER.COM.AU</p>	
<p>PROJECT PHILIP MCMASTER RESIDENTIAL DEVELOPMENT LOT 44 PANDORA STREET PERHWAITE</p>	<p>DATE 17/08/2024</p> <p>SCALE 1:50</p> <p>SHEET NO. A241</p>

FIRST FLOOR PLAN 1:100

- COMMON WALL
- 60mm CONCRETE WALL
- 100mm CONCRETE WALL
- 150mm CONCRETE WALL
- 200mm CONCRETE WALL
- 250mm CONCRETE WALL
- 300mm CONCRETE WALL
- 350mm CONCRETE WALL
- 400mm CONCRETE WALL
- 450mm CONCRETE WALL
- 500mm CONCRETE WALL
- 550mm CONCRETE WALL
- 600mm CONCRETE WALL
- 650mm CONCRETE WALL
- 700mm CONCRETE WALL
- 750mm CONCRETE WALL
- 800mm CONCRETE WALL
- 850mm CONCRETE WALL
- 900mm CONCRETE WALL
- 950mm CONCRETE WALL
- 1000mm CONCRETE WALL

UNIT NO.	AREA (SQM)	PERMITS	REMARKS
UNIT 1	120.00	100.00	
UNIT 2	120.00	100.00	
UNIT 3	120.00	100.00	
UNIT 4	120.00	100.00	
UNIT 5	120.00	100.00	
UNIT 6	120.00	100.00	
UNIT 7	120.00	100.00	
UNIT 8	120.00	100.00	
UNIT 9	120.00	100.00	
UNIT 10	120.00	100.00	
UNIT 11	120.00	100.00	
UNIT 12	120.00	100.00	
UNIT 13	120.00	100.00	
UNIT 14	120.00	100.00	
UNIT 15	120.00	100.00	
UNIT 16	120.00	100.00	
UNIT 17	120.00	100.00	
UNIT 18	120.00	100.00	
UNIT 19	120.00	100.00	
UNIT 20	120.00	100.00	
UNIT 21	120.00	100.00	
UNIT 22	120.00	100.00	
UNIT 23	120.00	100.00	
UNIT 24	120.00	100.00	
UNIT 25	120.00	100.00	
UNIT 26	120.00	100.00	
UNIT 27	120.00	100.00	
UNIT 28	120.00	100.00	
UNIT 29	120.00	100.00	
UNIT 30	120.00	100.00	
UNIT 31	120.00	100.00	
UNIT 32	120.00	100.00	
UNIT 33	120.00	100.00	
UNIT 34	120.00	100.00	
UNIT 35	120.00	100.00	
UNIT 36	120.00	100.00	
UNIT 37	120.00	100.00	
UNIT 38	120.00	100.00	
UNIT 39	120.00	100.00	
UNIT 40	120.00	100.00	
UNIT 41	120.00	100.00	
UNIT 42	120.00	100.00	
UNIT 43	120.00	100.00	
UNIT 44	120.00	100.00	
UNIT 45	120.00	100.00	
UNIT 46	120.00	100.00	
UNIT 47	120.00	100.00	
UNIT 48	120.00	100.00	
UNIT 49	120.00	100.00	
UNIT 50	120.00	100.00	
UNIT 51	120.00	100.00	
UNIT 52	120.00	100.00	
UNIT 53	120.00	100.00	
UNIT 54	120.00	100.00	
UNIT 55	120.00	100.00	
UNIT 56	120.00	100.00	
UNIT 57	120.00	100.00	
UNIT 58	120.00	100.00	
UNIT 59	120.00	100.00	
UNIT 60	120.00	100.00	
UNIT 61	120.00	100.00	
UNIT 62	120.00	100.00	
UNIT 63	120.00	100.00	
UNIT 64	120.00	100.00	
UNIT 65	120.00	100.00	
UNIT 66	120.00	100.00	
UNIT 67	120.00	100.00	
UNIT 68	120.00	100.00	
UNIT 69	120.00	100.00	
UNIT 70	120.00	100.00	
UNIT 71	120.00	100.00	
UNIT 72	120.00	100.00	
UNIT 73	120.00	100.00	
UNIT 74	120.00	100.00	
UNIT 75	120.00	100.00	
UNIT 76	120.00	100.00	
UNIT 77	120.00	100.00	
UNIT 78	120.00	100.00	
UNIT 79	120.00	100.00	
UNIT 80	120.00	100.00	
UNIT 81	120.00	100.00	
UNIT 82	120.00	100.00	
UNIT 83	120.00	100.00	
UNIT 84	120.00	100.00	
UNIT 85	120.00	100.00	
UNIT 86	120.00	100.00	
UNIT 87	120.00	100.00	
UNIT 88	120.00	100.00	
UNIT 89	120.00	100.00	
UNIT 90	120.00	100.00	
UNIT 91	120.00	100.00	
UNIT 92	120.00	100.00	
UNIT 93	120.00	100.00	
UNIT 94	120.00	100.00	
UNIT 95	120.00	100.00	
UNIT 96	120.00	100.00	
UNIT 97	120.00	100.00	
UNIT 98	120.00	100.00	
UNIT 99	120.00	100.00	
UNIT 100	120.00	100.00	

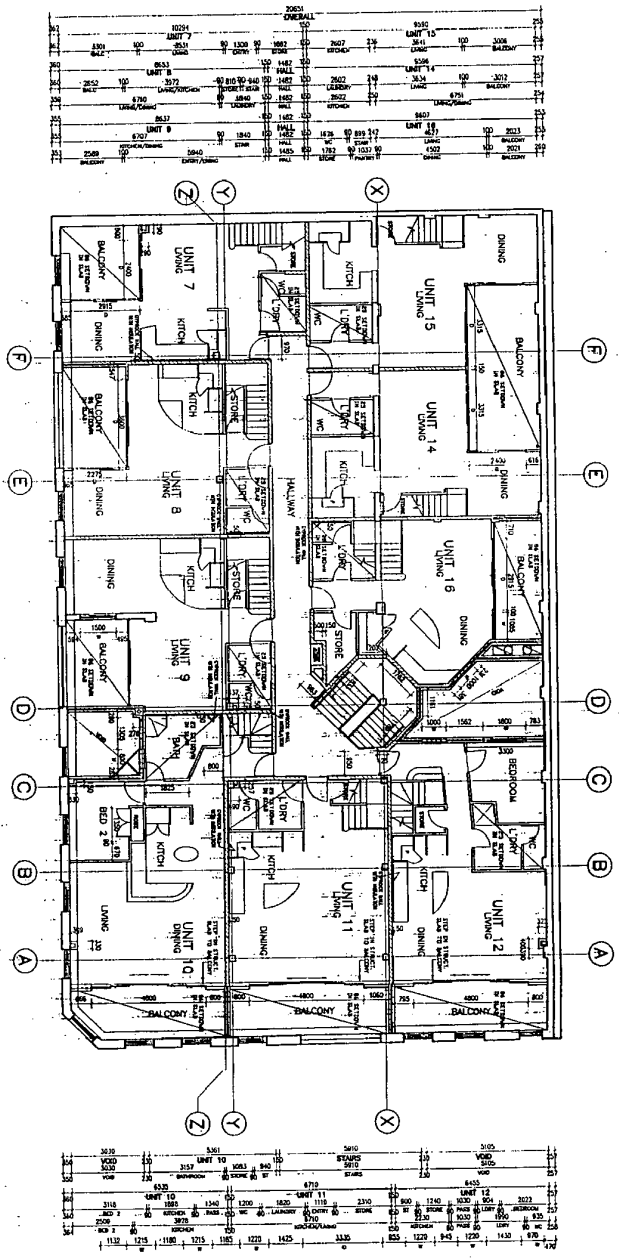

UNIT NO.	AREA (SQM)	PERMITS	REMARKS
UNIT 1	120.00	100.00	
UNIT 2	120.00	100.00	
UNIT 3	120.00	100.00	
UNIT 4	120.00	100.00	
UNIT 5	120.00	100.00	
UNIT 6	120.00	100.00	
UNIT 7	120.00	100.00	
UNIT 8	120.00	100.00	
UNIT 9	120.00	100.00	
UNIT 10	120.00	100.00	
UNIT 11	120.00	100.00	

NOTE: ALL AREAS SHOWN ARE APPROXIMATE. CONTRACTOR TO VERIFY ALL DIMENSIONS AND LOCATIONS ON SITE. ALL DIMENSIONS ARE TO FACE UNLESS OTHERWISE SPECIFIED. ALL DIMENSIONS ARE TO FACE UNLESS OTHERWISE SPECIFIED.





PHILIP MCALLISTER
 ARCHITECT
 10/1100 11th Street, Perth WA 6000
 PH: 9442 1111
 FAX: 9442 1112
 WWW.PHILIPMCALLISTER.COM.AU

PROJECT: PHILIP MCALLISTER
 PHASE: ARCHITECTURAL DESIGN
 DATE: 25/08/2023

APPROVED: [Signature]
 DATE: 25/08/2023

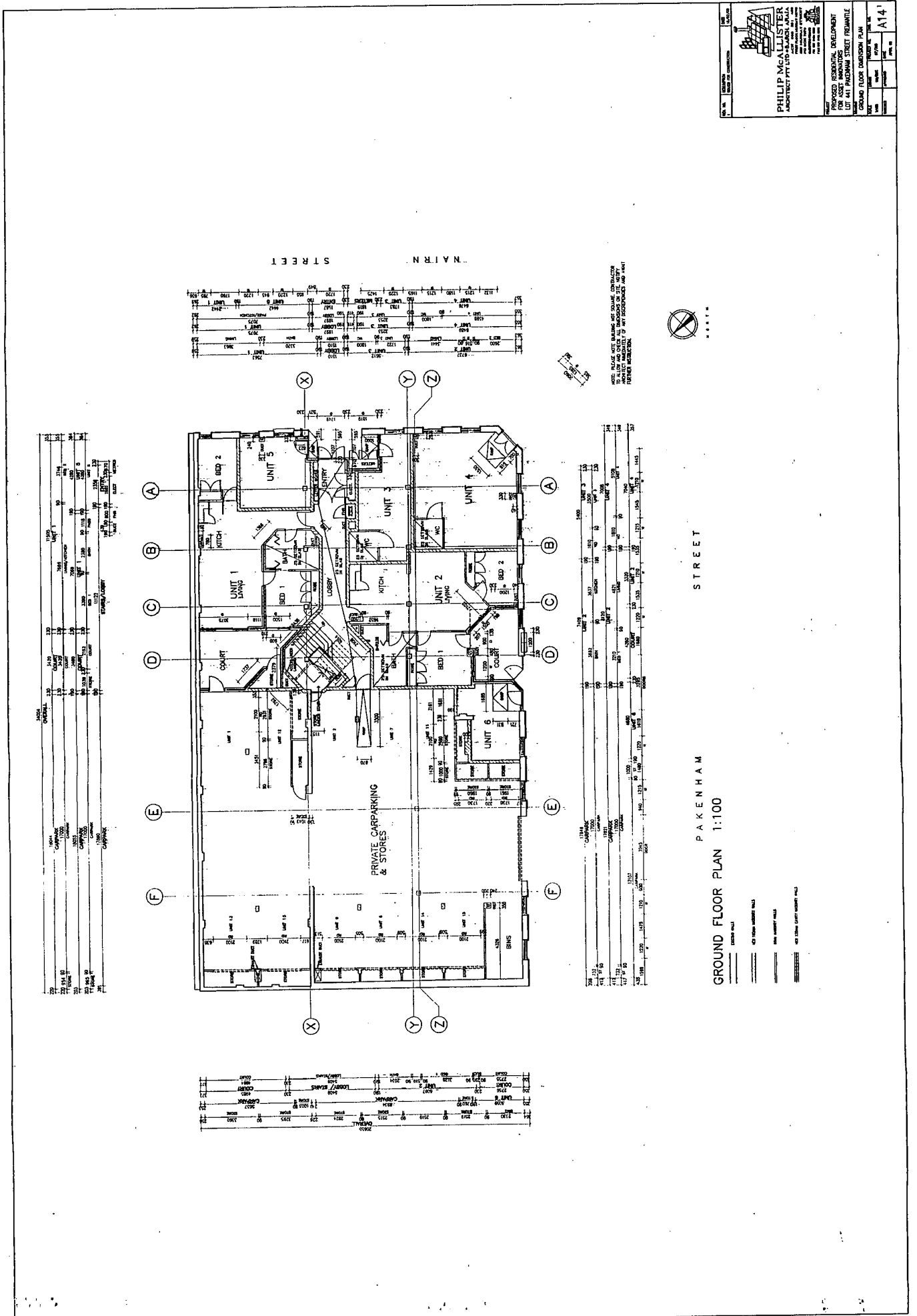
PHILIP MCALLISTER ARCHITECTS
 10/1100 11th Street, Perth WA 6000
 PH: 9442 1111
 FAX: 9442 1112
 WWW.PHILIPMCALLISTER.COM.AU











PHILIP McALLISTER ARCHITECTS
 11/11 WILSON STREET
 PERTH WESTERN AUSTRALIA 6008
 TEL: 08 9442 1111
 FAX: 08 9442 1112
 WWW.PHILIPMCALLISTER.COM.AU

PROPOSED RESIDENTIAL DEVELOPMENT
 1/11 WILSON STREET
 PERTH WESTERN AUSTRALIA 6008
 SHEET NO. **A13**

DATE	BY	APPROVED
17/08	PJ/AM	
18/08	AM/AM	
19/08	AM/AM	
20/08	AM/AM	
21/08	AM/AM	
22/08	AM/AM	
23/08	AM/AM	
24/08	AM/AM	
25/08	AM/AM	
26/08	AM/AM	
27/08	AM/AM	
28/08	AM/AM	
29/08	AM/AM	
30/08	AM/AM	
31/08	AM/AM	
01/09	AM/AM	
02/09	AM/AM	
03/09	AM/AM	
04/09	AM/AM	
05/09	AM/AM	
06/09	AM/AM	
07/09	AM/AM	
08/09	AM/AM	
09/09	AM/AM	
10/09	AM/AM	
11/09	AM/AM	
12/09	AM/AM	
13/09	AM/AM	
14/09	AM/AM	
15/09	AM/AM	
16/09	AM/AM	
17/09	AM/AM	
18/09	AM/AM	
19/09	AM/AM	
20/09	AM/AM	
21/09	AM/AM	
22/09	AM/AM	
23/09	AM/AM	
24/09	AM/AM	
25/09	AM/AM	
26/09	AM/AM	
27/09	AM/AM	
28/09	AM/AM	
29/09	AM/AM	
30/09	AM/AM	
01/10	AM/AM	
02/10	AM/AM	
03/10	AM/AM	
04/10	AM/AM	
05/10	AM/AM	
06/10	AM/AM	
07/10	AM/AM	
08/10	AM/AM	
09/10	AM/AM	
10/10	AM/AM	
11/10	AM/AM	
12/10	AM/AM	
13/10	AM/AM	
14/10	AM/AM	
15/10	AM/AM	
16/10	AM/AM	
17/10	AM/AM	
18/10	AM/AM	
19/10	AM/AM	
20/10	AM/AM	
21/10	AM/AM	
22/10	AM/AM	
23/10	AM/AM	
24/10	AM/AM	
25/10	AM/AM	
26/10	AM/AM	
27/10	AM/AM	
28/10	AM/AM	
29/10	AM/AM	
30/10	AM/AM	
31/10	AM/AM	
01/11	AM/AM	
02/11	AM/AM	
03/11	AM/AM	
04/11	AM/AM	
05/11	AM/AM	
06/11	AM/AM	
07/11	AM/AM	
08/11	AM/AM	
09/11	AM/AM	
10/11	AM/AM	
11/11	AM/AM	
12/11	AM/AM	
13/11	AM/AM	
14/11	AM/AM	
15/11	AM/AM	
16/11	AM/AM	
17/11	AM/AM	
18/11	AM/AM	
19/11	AM/AM	
20/11	AM/AM	
21/11	AM/AM	
22/11	AM/AM	
23/11	AM/AM	
24/11	AM/AM	
25/11	AM/AM	
26/11	AM/AM	
27/11	AM/AM	
28/11	AM/AM	
29/11	AM/AM	
30/11	AM/AM	
01/12	AM/AM	
02/12	AM/AM	
03/12	AM/AM	
04/12	AM/AM	
05/12	AM/AM	
06/12	AM/AM	
07/12	AM/AM	
08/12	AM/AM	
09/12	AM/AM	
10/12	AM/AM	
11/12	AM/AM	
12/12	AM/AM	
13/12	AM/AM	
14/12	AM/AM	
15/12	AM/AM	
16/12	AM/AM	
17/12	AM/AM	
18/12	AM/AM	
19/12	AM/AM	
20/12	AM/AM	
21/12	AM/AM	
22/12	AM/AM	
23/12	AM/AM	
24/12	AM/AM	
25/12	AM/AM	
26/12	AM/AM	
27/12	AM/AM	
28/12	AM/AM	
29/12	AM/AM	
30/12	AM/AM	
31/12	AM/AM	

CEILING LEGEND

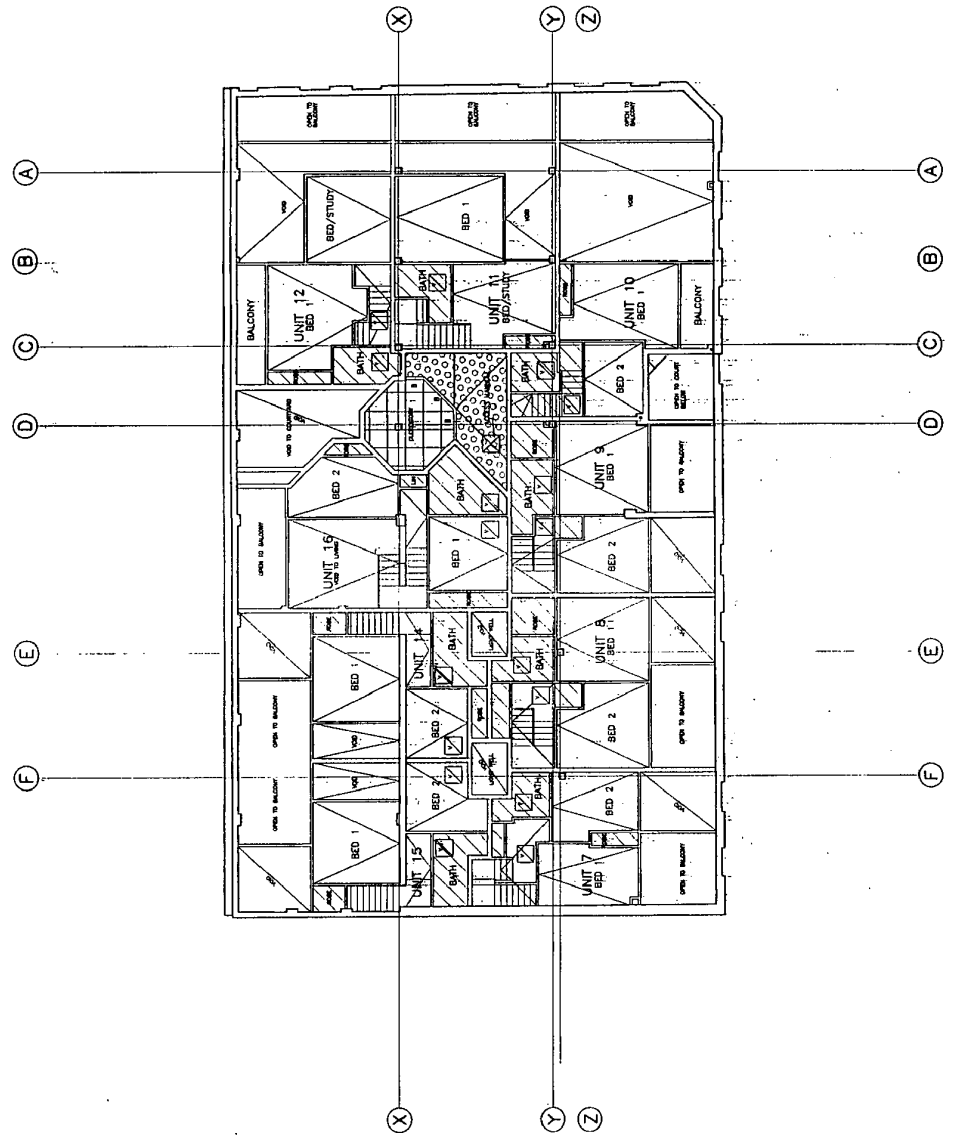
	SMOOTH PLASTER CEILING
	SMOOTH PLASTER CEILING AT 2.40M MAX
	SMOOTH PLASTER CEILING AT 2.40M MAX
	SEE OTHER DRAWING
	SMOOTH PLASTER CEILING
	SMOOTH PLASTER CEILING WITH RECESSED LIGHT FIXTURES
	SMOOTH PLASTER CEILING WITH RECESSED LIGHT FIXTURES



REFLECTED CEILING PLAN - MEZZANINE
SCALE 1:100

DATE	DESCRIPTION	BY

PHILIP McALLISTER
 ARCHITECT PTY LTD
 10/1100 WILSON STREET
 PERTH WA 6000
 PH: 08 9447 1111
 FAX: 08 9447 1112
 WWW: PHILIPMCALLISTER.COM.AU

PROPOSED RESIDENTIAL DEVELOPMENT
 10/1100 WILSON STREET
 LOT 411 PARADISE STREET, PERTH WA

PROJECT	NO. OF SHEETS	NO. OF SHEETS

DATE: 20/08/2023
 DRAWN BY: PHILIP MCALLISTER
 CHECKED BY: PHILIP MCALLISTER
 SCALE: AS SHOWN
 AOB

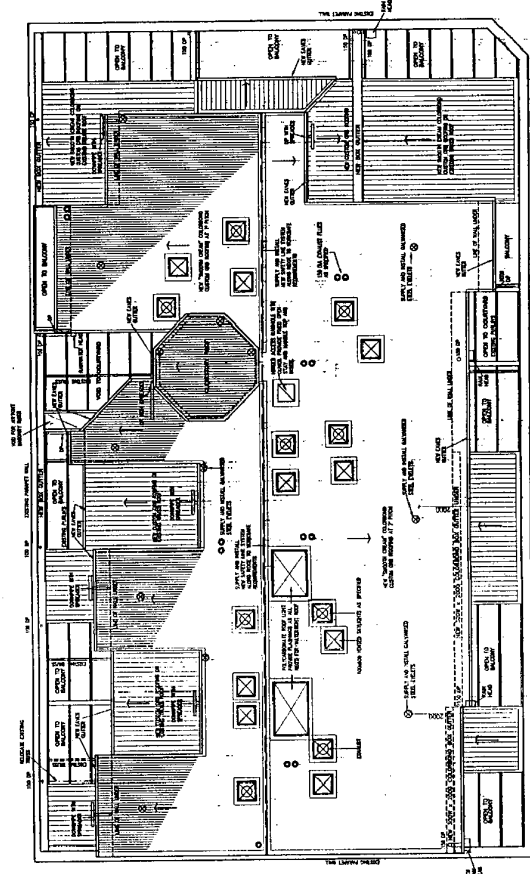

ROOF PLAN 1:100

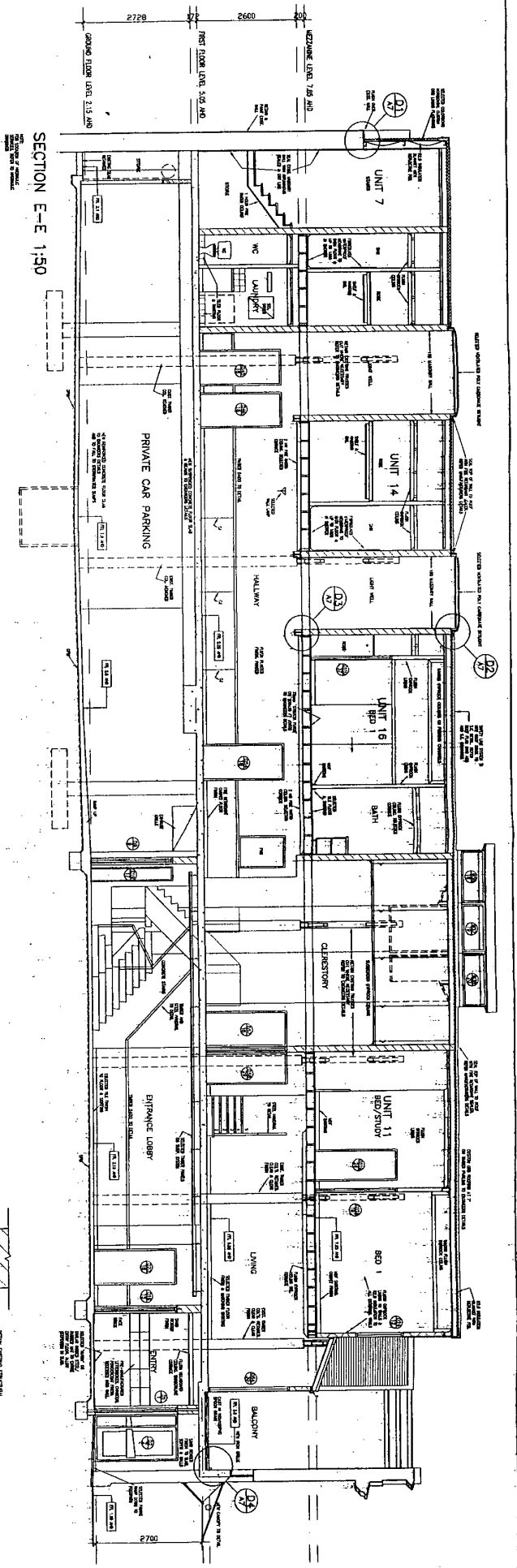

SECTION E-E 1:50

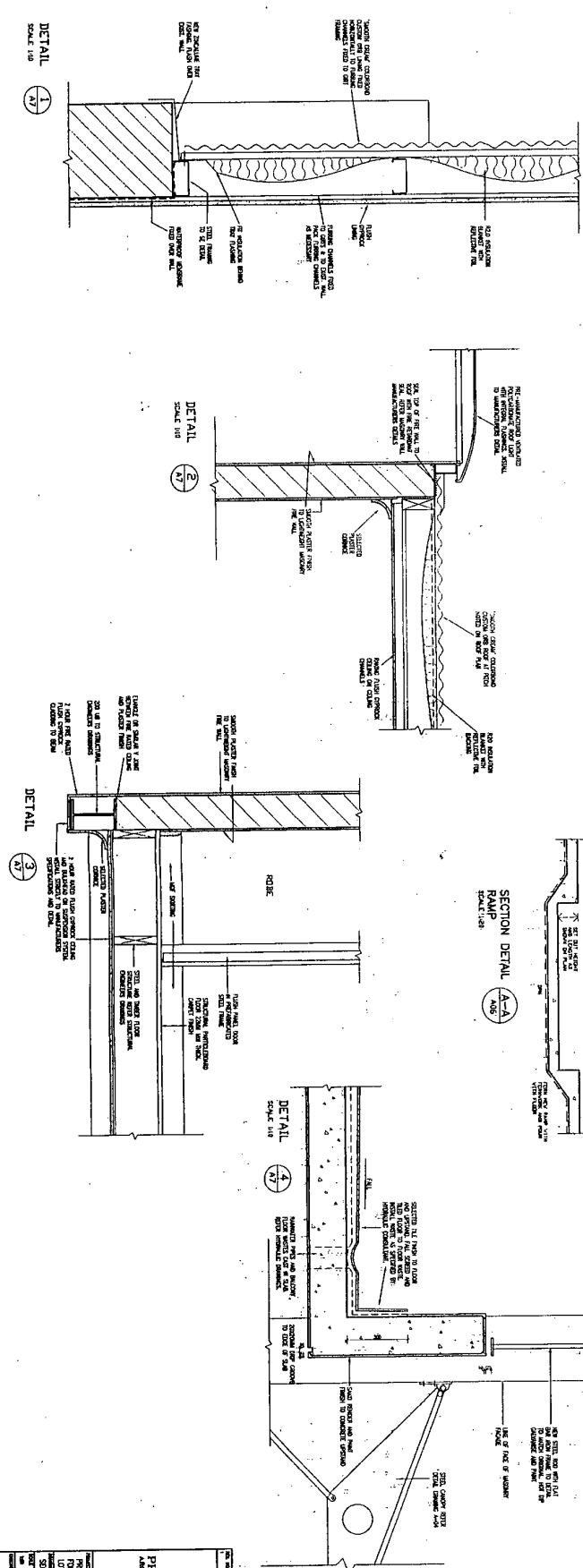

<p>PHILIP McALLISTER ARCHITECT PTY LTD 100/102 WILSON STREET PERTH WA 6000 PH: 08 9442 2222 FAX: 08 9442 2223 WWW.PHILIPMCALLISTER.COM.AU</p>		<p>PROPOSED RESIDENTIAL DEVELOPMENT UNIT 10/11/14/16/17/18/19/20/21/22/23/24/25/26/27/28/29/30/31/32/33/34/35/36/37/38/39/40/41/42/43/44/45/46/47/48/49/50/51/52/53/54/55/56/57/58/59/60/61/62/63/64/65/66/67/68/69/70/71/72/73/74/75/76/77/78/79/80/81/82/83/84/85/86/87/88/89/90/91/92/93/94/95/96/97/98/99/100</p>
<p>SECTION E-E SCALE 1:50 DATE 10/10/2017</p>	<p>NO. 10 GALVANIZED STEEL DECK 100mm POLYSTYRENE INSULATION CONCRETE SLAB</p>	<p>NO. 10 GALVANIZED STEEL DECK 100mm POLYSTYRENE INSULATION CONCRETE SLAB</p>

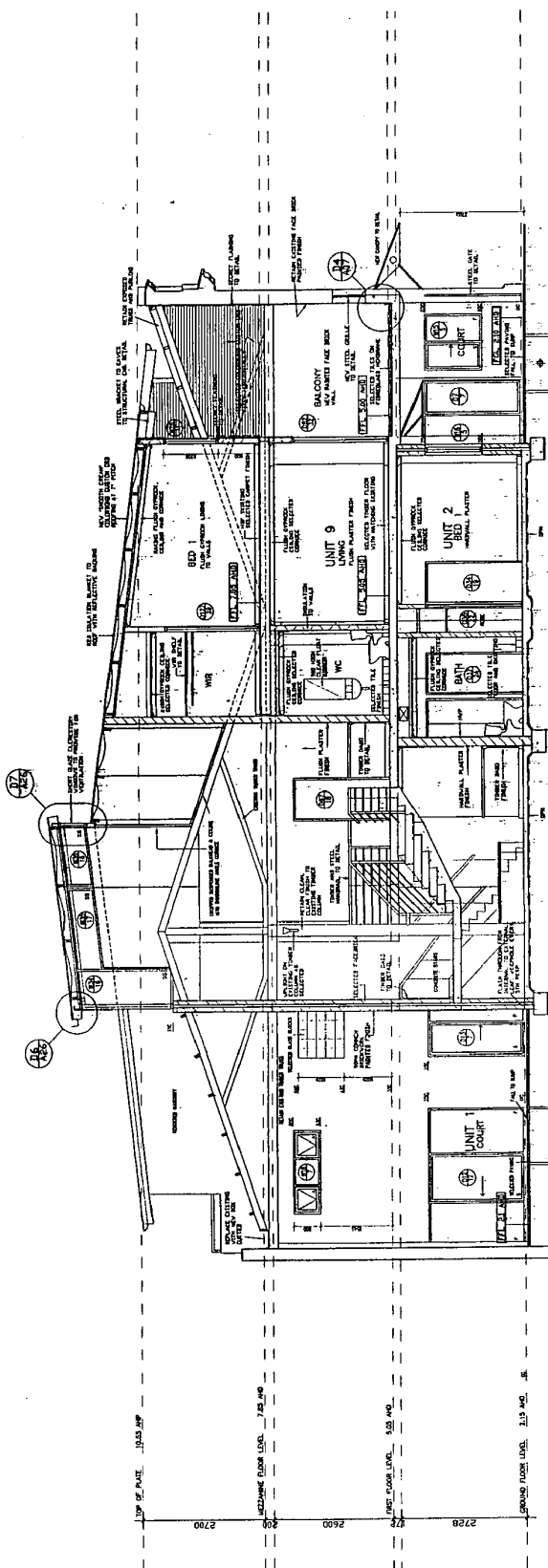

SECTION C-C 1:50

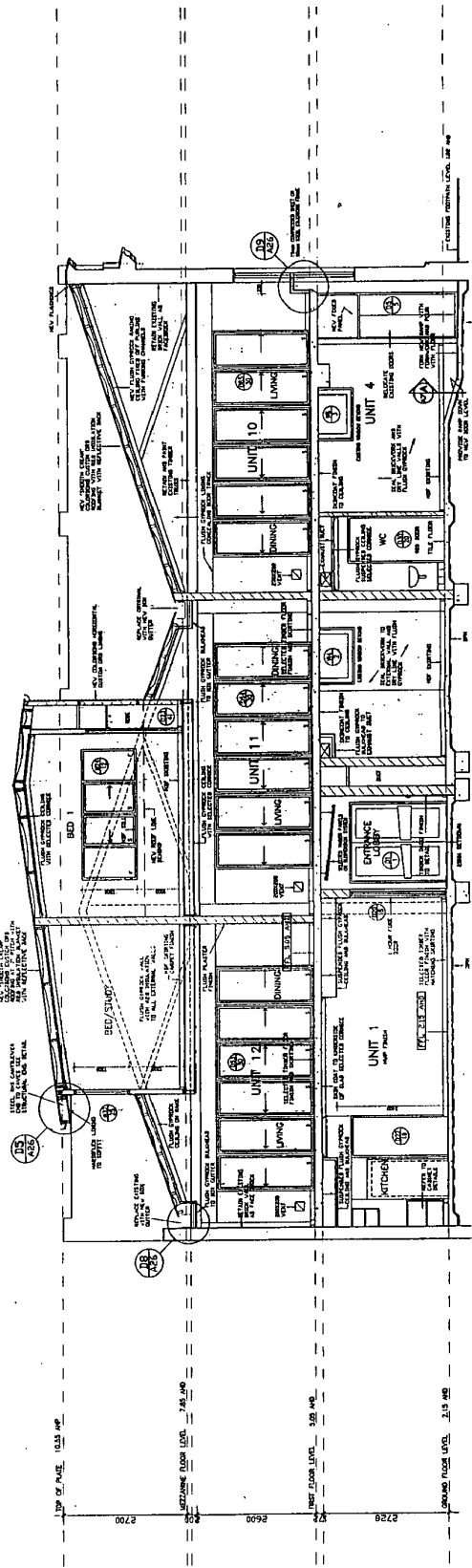

SECTION D-D 1:50

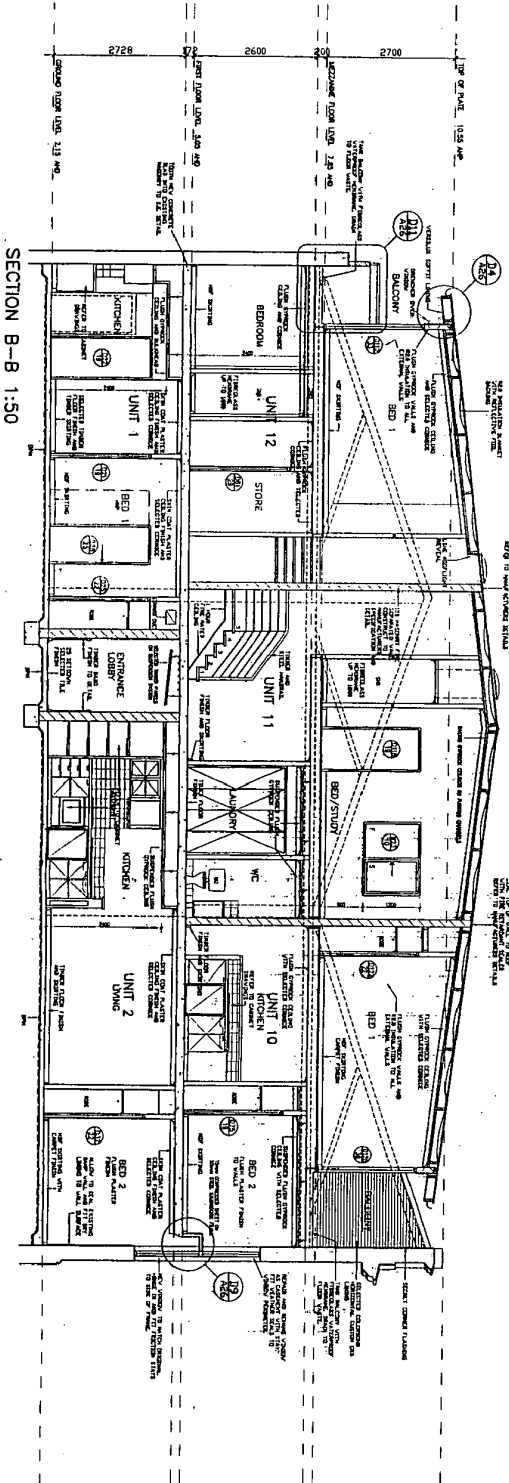

SECTION B-A 1:50

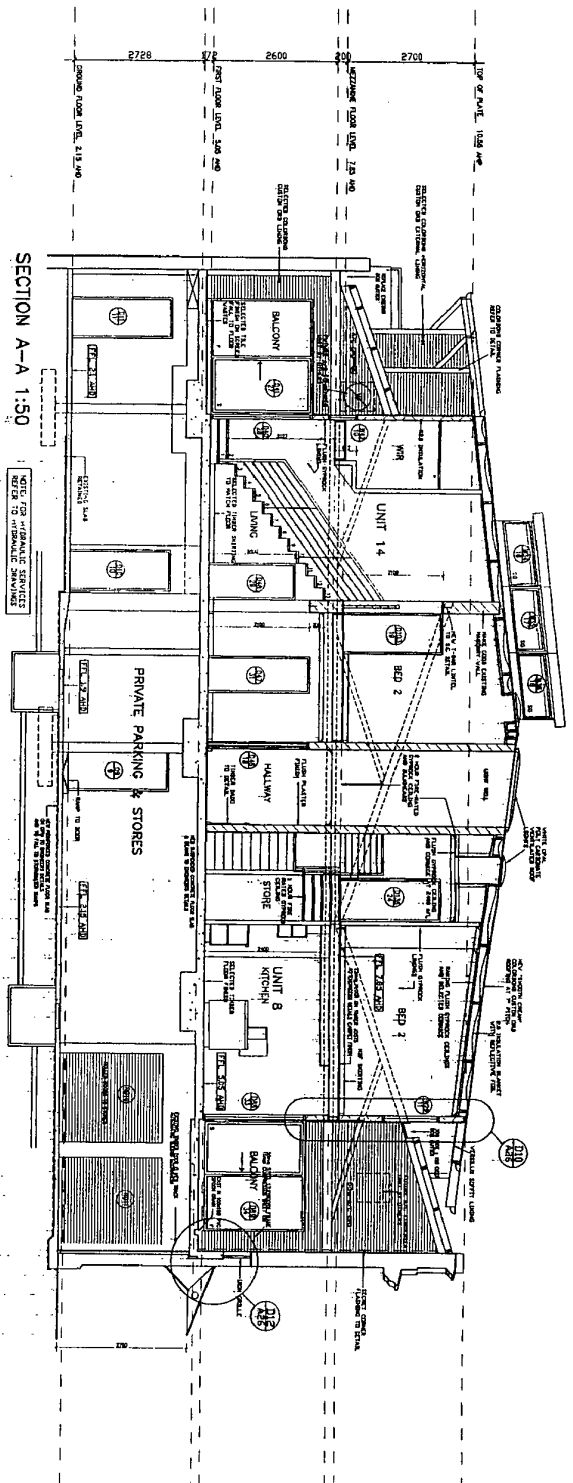

SECTION A-A 1:50

PHILIP MCALLISTER
 ARCHITECT
 100/102 ROYAL OAK AVENUE
 WEST PERTH WA 6150
 PH: 9447 1111
 FAX: 9447 1112
 WWW.PHILIPMCALLISTER.COM.AU

PROJECT: RESIDENTIAL DEVELOPMENT
 100/102 ROYAL OAK AVENUE
 WEST PERTH WA 6150

DRAWING: SECTION B-A 1:50
 DATE: 25/08/2023

NO.	DATE	DESCRIPTION
1	25/08/2023	ISSUED FOR PERMIT
2	25/08/2023	ISSUED FOR PERMIT
3	25/08/2023	ISSUED FOR PERMIT
4	25/08/2023	ISSUED FOR PERMIT
5	25/08/2023	ISSUED FOR PERMIT
6	25/08/2023	ISSUED FOR PERMIT
7	25/08/2023	ISSUED FOR PERMIT
8	25/08/2023	ISSUED FOR PERMIT
9	25/08/2023	ISSUED FOR PERMIT
10	25/08/2023	ISSUED FOR PERMIT
11	25/08/2023	ISSUED FOR PERMIT
12	25/08/2023	ISSUED FOR PERMIT
13	25/08/2023	ISSUED FOR PERMIT
14	25/08/2023	ISSUED FOR PERMIT
15	25/08/2023	ISSUED FOR PERMIT
16	25/08/2023	ISSUED FOR PERMIT
17	25/08/2023	ISSUED FOR PERMIT
18	25/08/2023	ISSUED FOR PERMIT
19	25/08/2023	ISSUED FOR PERMIT
20	25/08/2023	ISSUED FOR PERMIT
21	25/08/2023	ISSUED FOR PERMIT
22	25/08/2023	ISSUED FOR PERMIT
23	25/08/2023	ISSUED FOR PERMIT
24	25/08/2023	ISSUED FOR PERMIT
25	25/08/2023	ISSUED FOR PERMIT
26	25/08/2023	ISSUED FOR PERMIT
27	25/08/2023	ISSUED FOR PERMIT
28	25/08/2023	ISSUED FOR PERMIT
29	25/08/2023	ISSUED FOR PERMIT
30	25/08/2023	ISSUED FOR PERMIT
31	25/08/2023	ISSUED FOR PERMIT
32	25/08/2023	ISSUED FOR PERMIT
33	25/08/2023	ISSUED FOR PERMIT
34	25/08/2023	ISSUED FOR PERMIT
35	25/08/2023	ISSUED FOR PERMIT
36	25/08/2023	ISSUED FOR PERMIT
37	25/08/2023	ISSUED FOR PERMIT
38	25/08/2023	ISSUED FOR PERMIT
39	25/08/2023	ISSUED FOR PERMIT
40	25/08/2023	ISSUED FOR PERMIT
41	25/08/2023	ISSUED FOR PERMIT
42	25/08/2023	ISSUED FOR PERMIT
43	25/08/2023	ISSUED FOR PERMIT
44	25/08/2023	ISSUED FOR PERMIT
45	25/08/2023	ISSUED FOR PERMIT
46	25/08/2023	ISSUED FOR PERMIT
47	25/08/2023	ISSUED FOR PERMIT
48	25/08/2023	ISSUED FOR PERMIT
49	25/08/2023	ISSUED FOR PERMIT
50	25/08/2023	ISSUED FOR PERMIT

PHILIP MCCALLISTER ARCHITECTS PTY LTD
 ARCHITECTS
 10/110 WILSON STREET
 NORTH BRISBANE QLD 4006
 PH: 07 3251 1111
 FAX: 07 3251 1112
 WWW.PHILIPMCCALLISTER.COM.AU

PROJECT: PROPOSED RESIDENTIAL DEVELOPMENT FOR ASSESSMENT
 LOT 411 PAKENHAM STREET FRONTRAIL
 1-100 ELEVATIONS

DATE:	12/01/2023	SCALE:	AS SHOWN
BY:	PHILIP MCCALLISTER	PROJECT NO.:	23000000000000000000
CHECKED BY:	PHILIP MCCALLISTER	DATE:	12/01/2023
APPROVED BY:	PHILIP MCCALLISTER	SCALE:	AS SHOWN

SHEET NO. **A04'**
 OF **10**

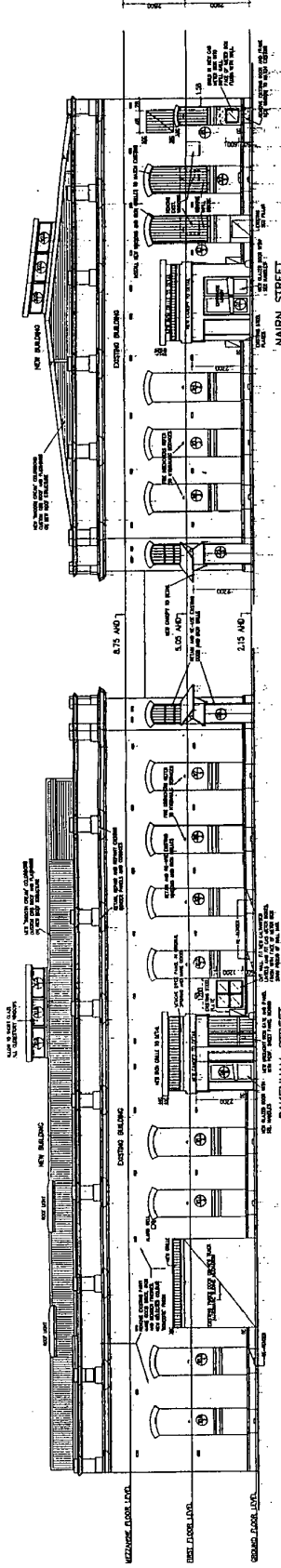

SOUTH EAST ELEVATION 1:100
NAIRN STREET

SOUTH WEST ELEVATION 1:100
PAKENHAM STREET

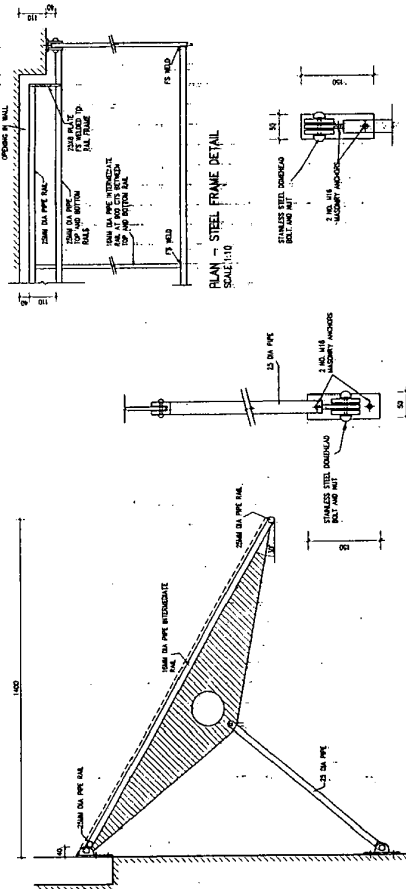

FRONT ELEVATION
TOP BRACKET DETAIL
SCALE 1:3

FRONT ELEVATION - SIDE STAY DETAIL
SCALE 1:5

CANOPY DETAIL
SCALE 1:10
NOTE: REFER TO STRUCTURAL ENGINEERS DETAILS FOR PIPE AND PLATE DIMENSIONS

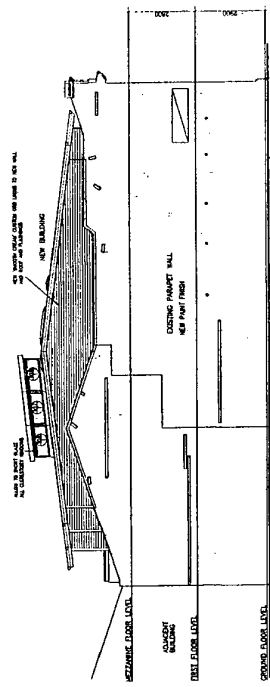

NORTH WEST ELEVATION 1:100

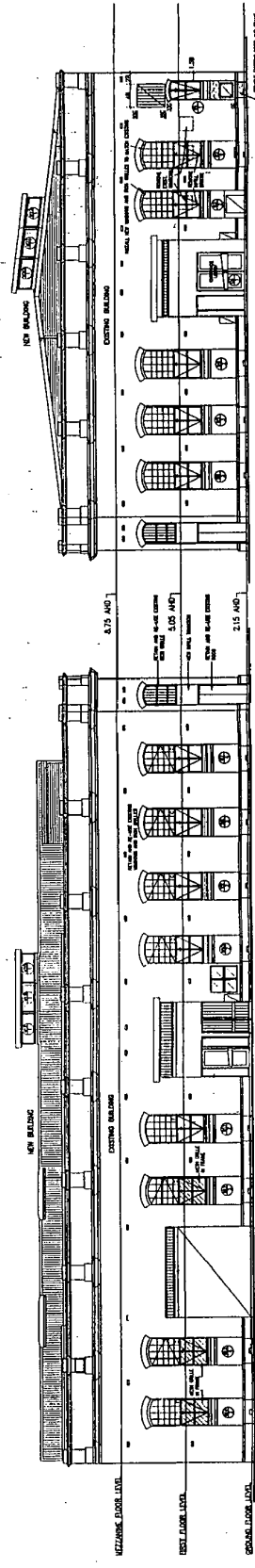

SOUTH EAST ELEVATION 1:100
NAIRN STREET

SOUTH WEST ELEVATION 1:100
PAKENHAM STREET

 PHILIP McALLISTER ARCHITECT PTY LTD 15/1000 JARVIS ST SYDNEY NSW 2000 PH: 02 9550 1000 FAX: 02 9550 1001 WWW: PHILIPMCALLISTER.COM.AU	
PROPOSED RESIDENTIAL DEVELOPMENT FOR ASSET INNOVATIONS 441 PAKENHAM STREET ROSHARON GROUND FLOOR PLAN	
DATE	NO.
ISSUED	01
REVISED	
DATE	NO.
ISSUED	A01

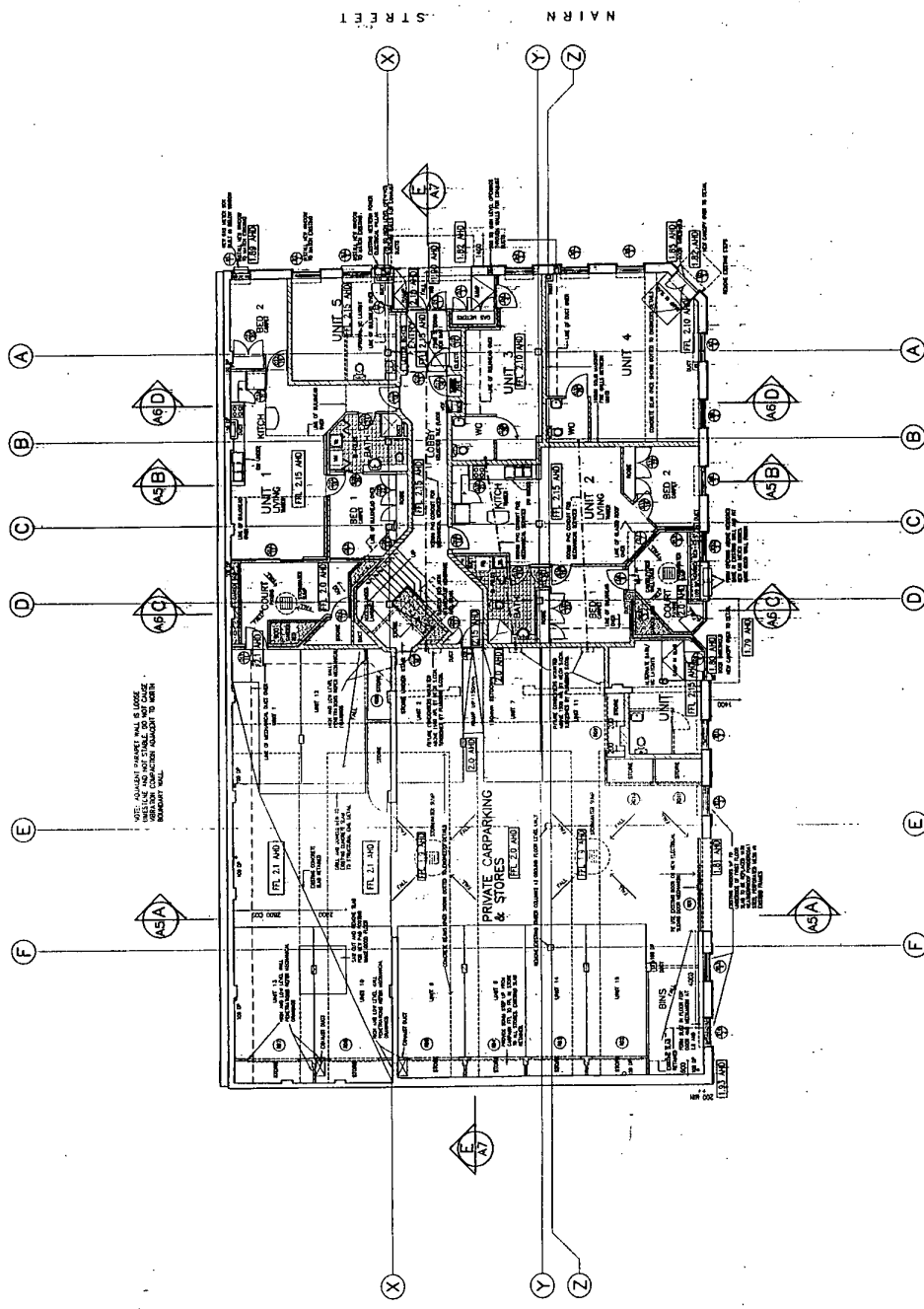

PAKENHAM STREET
 GROUND FLOOR PLAN 1:100

- CORE WALL
- 100mm CONCRETE WALL
- 200mm CONCRETE WALL
- 400mm CONCRETE WALL

ITEM No. 3 IN SCHEDULE

CONSTRUCTION PLANS FOR THE BUILDING WORKS.

3. Instruct solicitors, attend conferences and generally supervise legal proceedings involving the Strata Company.
4. Arrange and attend meetings of the Strata Company or its Council additional to those specified in Schedule 2 Part I, including any adjourned meeting.
5. Attendances at the building otherwise than as specified in Schedule 2 Part I.
6. Arrange other than normal day to day maintenance, repair and replacement of the common property and personal property vested in the Strata Company.
7. Liaise with architects, engineers, surveyors, builders and the like in relation to any work carried out by the Strata Company Manager pursuant to this deed.
8. To do any other thing not specified in Schedule 2 Part I to this deed.
9. Such matters to be charged at the rates specified in Schedule 1 Part II.

Executed by the Strata Company:

THE COMMON SEAL OF THE OWNERS OF
_____ - STRATA PLAN No. _____
was hereunto affixed on _____
in the presence of:

Member of Council.

Member of Council.

Signed/Sealed by the Strata Company Manager:

PAGE 4.

SCHEDULE 2.

PART I.

Duties and functions covered by the management fee specified in Schedule I Part I:

1. Act as secretary and treasurer of the Strata Company and exercise and perform the powers and duties specified in the Act in respect of those officers.
2. Arrange as required by the Strata Company normal day to day maintenance, repair and replacement of the common property and personal property vested in the Strata Company, but excluding any special attendance at the building for this purpose.
3. Inspect the buildings and other common property as required.
4. Arrange and attend the Annual General Meeting.
5. Act (upon request by, or in the absence of, the Chairman) as Chairman of any meeting of the Strata Company or its Council.
6. Ensure that insurances are effected and promptly renewed in accordance with the Act and make necessary insurance claims.
7. Keep any wage, income tax or other records required by any law from time to time in respect of any employees or contractors of the Strata Company and complete and submit any returns in respect thereof.
8. Arrange for the preparation and submission of income tax returns on behalf of the Strata Company and accept appointment as the Public Officer of the Strata Company.
9. Disburse monies in accordance with the Act and the terms of this deed.
10. Maintain the records of the Strata Company as required by the Act.
11. Prepare as necessary budgets and reports and keep all records to facilitate such preparation.
12. Have possession of and care for the records of the Strata Company.
13. Implement credit control procedures in respect of maintenance contributions and advise regarding recovery.
14. Have custody of the common seal and attest its fixation for the purpose of exercising or performing any of the powers, authorities, duties or functions conferred or imposed by the terms of this or her deed.
15. Comply with all requirements at law and pursuant to the Act as they relate to the strata scheme.
16. Administer the by-laws of the Strata Company as are contained in Schedule 3 to this deed.

SCHEDULE 2.

PART II.

Duties and functions not covered by the management fee:

1. Making applications and submissions to the Strata Titles Referee, Land Titles Office, local government authority or any other authority, Tribunal or government department.
2. Attend any hearing conducted by the Strata Titles Referee or any Tribunal or Court.

cont.../5.

8. AUTHORITY OF PAYMENT TO THE STRATA COMPANY MANAGER.

the Strata Company Manager is authorised to disburse funds of the Strata Company for the purpose of:

- 8.1. carrying out a duty or obligation in respect of the management of the Strata Company specified in Schedule 2 Part I;
- 8.2. paying monies in accordance with a budget approved by the Strata Company;
- 8.3. payment of insurance premiums;
- 8.4. payment of sums required for the repair and maintenance of common property or personal property pursuant to section 38 of the Act;
- 8.5. payment of audit, accountants or legal fees;
- 8.6. payment of all other day to day expenses incurred by the Strata Company;
- 8.7. the Strata Company Manager is authorised to determine whether any funds of the Strata Company are excess to immediate requirement of the Strata Company from time to time and if the Strata Company Manager so determines those funds may be transferred by the Strata Company Manager into any form of authorised trustee investment, such investment to be in the name of the Strata Company.

9. BANKING AUTHORITY TO THE STRATA COMPANY MANAGER.

the Strata Company Manager is authorised to operate banking facilities for funds of the Strata Company, such accounts to be in the name of the Strata Company.

10. AUTHORITY TO AFFIX THE COMMON SEAL OF THE STRATA COMPANY.

the Strata Company authorises the Strata Company Manager to affix the common seal of the Strata Company to any documents which the Strata Company has by resolution authorised the Strata Company Manager to affix the common seal.

11. INDEMNITY OF THE STRATA COMPANY.

the Strata Company will indemnify the Strata Company Manager for all costs and expenses (including legal costs) properly incurred in carrying out work pursuant to this deed.

**SCHEDULE 1.
PART I**

DURATION OF APPOINTMENT: _____

APPOINTMENT COMMENCEMENT DATE: _____

MANAGEMENT FEE: _____

REVIEW DATE: The yearly anniversary of the "appointment commencement date".

PART II

ADDITIONAL FEES:

In accordance with the Real Estate & Business Agents Act, regulations.

cont..../4.

4. FEES PAYABLE TO THE STRATA COMPANY MANAGER.

- 4.1. From the date of commencement of the appointment of the Strata Company Manager until termination of such appointment the Strata Company will pay a management fee to the Strata Company Manager such fee to be as specified in Schedule 1 to this deed.
- 4.2. The management fee is payable by equal monthly instalments in arrears.
- 4.3. In addition to the management fee the Strata Company will pay to the Strata Company Manager additional fees, as specified in Schedule 1 Part II to this deed, in respect of all other work other than that specified in Schedule 2 Part I, performed by the Strata Company Manager, as specified in Schedule 2 Part II or other duties agreed to between the Strata Company and the Strata Company Manager.
- 4.4. the Strata Company will also reimburse the Strata Company Manager for all disbursements incurred by the Strata Company Manager in carrying out its duties as specified in Schedule 2 to this deed, including such items as printing, stationary, telephone, photocopies, computer fees, postage, bank charges and audit fees.
- 4.5. the Strata Company will also pay to the Strata Company Manager further fees in an amount equivalent to the amount received by the Strata Company in respect of applications made under section 43 of the Act.

Such additional fees to be payable monthly in arrears.

5. VARIATION OF FEES PAYABLE TO THE STRATA COMPANY MANAGER.

The management fee and additional fees specified in Schedule 1 and Schedule 2 shall be reviewed on each review date as specified in Schedule 1 by agreement between the Strata Company and the Strata Company Manager.

6. TERMINATION OF APPOINTMENT OF THE STRATA COMPANY MANAGER.

The termination of the appointment of the Strata Company Manager prior to the duration specified in Schedule 1 can only be effected by one or more of the following acts or events occurring:

- 6.1. An order of the Strata Titles Referee in accordance with section 102 of the Act to appoint an administrator to the strata scheme.
- 6.2. Upon an order of the Supreme Court in accordance with section 31 of the Act to terminate the strata scheme.
- 6.3. By a majority resolution of the Strata Company to terminate the appointment of the Strata Company Manager, in which case a period of notice of three months shall be given to the Strata Company Manager, by the Strata Company, advising of the resolution of the Strata Company to terminate the appointment and such notice shall commence from the first day of the month following the month in which the resolution of the Strata Company to terminate such appointment was passed.
- 6.4. Upon the termination of the strata scheme by any means other than those previously referred to.

7. EMPLOYMENT OF STAFF BY THE STRATA COMPANY MANAGER.

the Strata Company Manager is authorised to employ whatever persons, firms, organisations or companies it may deem necessary to employ to carry out its duties as specified in Schedule 2.

cont.../3.

STRATA COMPANY MANAGEMENT AGREEMENT

This agreement dated _____ day of _____

BETWEEN:

THE OWNERS OF _____ - STRATA PLAN No. _____ (hereinafter referred to as "the Strata Company".) being a body corporate constituted pursuant to section 32 of the Strata Titles Act 1985, as amended, (hereinafter referred to as "the Act".)

AND

_____ of _____
(hereinafter referred to as "the Strata Company Manager".)

WHEREAS:

- a) the Strata Company has resolved, in accordance with Schedule 2 by-laws 17, 18, 19 and 20 of the Strata Company, to appoint the Strata Company Manager as its agent for the management of the affairs of the Strata Company, the performance of the duties of the Strata Company and delegates all the powers of the Strata Company to the Strata Company Manager together with the powers of the Council of the Strata Company, in accordance with Schedule 1 by-law 8 (2) (b) and Schedule 2 by-law 17 of the Strata Company, as may be amended from time to time.
- b) the Strata Company Manager agrees to accept the responsibilities and obligations of the Strata Company as contained in sections 35, 35A and 36 (1) of the Act and to also perform those other duties of the Strata Company as contained in section 36 (2) of the Act together with exercising the powers of the Strata Company in accordance with section 37 of the Act and Schedule 1 by-law 8 (2) (b), as directed from time to time by the Strata Company.

NOW THIS DEED WITNESSETH as follows:

1. APPOINTMENT OF THE STRATA COMPANY MANAGER.

the Strata Company has resolved to appoint the Strata Company Manager from the commencement date and for the duration contained in the Schedule 1 to this deed, such appointment to continue at the expiration of the duration on a three monthly basis until such time as a new appointment of a Manager is made.

2. POWERS OF THE STRATA COMPANY MANAGER.

- (a) It is agreed by the parties hereto that the Strata Company Manager shall perform all of the duties and functions of the Strata Company, its Council, and of the Chairman, Secretary and Treasurer of the Strata Company as directed by the Strata Company from time to time; and
- (b) the Strata Company appoints the Strata Company Manager as its agent to carry out the duties of the Strata Company and the Strata Company Manager accepts the appointment as agent of the Strata Company.

3. DUTIES OF THE STRATA COMPANY MANAGER.

It is agreed by the parties hereto that in consideration of the Strata Company paying and continuing to pay the management fees to the Strata Company Manager in accordance with Clause 4 of this deed the Strata Company Manager will do all the things specified in Schedule 2 to this deed.

cont.../2.

magree-7.doc

ITEM No. 2 IN SCHEDULE

**STRATA COMPANY MANAGEMENT AGREEMENT REFERRED TO IN
SCHEDULE 2 BY-LAW No. 18.**

FORM 27

Strata Titles Act 1985

Regulation 37 (1) (a)

STRATA PLAN No. 37612.

CERTIFICATE OF LICENSED VALUER

I, PAUL A. SMITH, being a Licensed Valuer under the *Land Valuers Licensing Act 1978* hereby certify that if a re-subdivision were effected in accordance with a by-law of the strata/survey-strata scheme made under clause 8 of Schedule 2A of the Act, on the basis of information provided in the by-law pursuant to clause 8 (a) of Schedule 2A, a licensed valuer would be able to provide a certificate required under section 14 (2) in respect of the proposed unit entitlement.

15/3/2000
Date

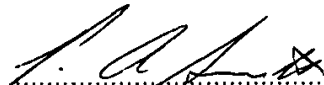
Licensed Valuer

ANNEXURE OF STRATA PLAN No. 37612

SCHEDULE OF UNIT ENTITLEMENT		OFFICE USE ONLY CURRENT Cs. of TITLE		SCHEDULE OF UNIT ENTITLEMENT		OFFICE USE ONLY CURRENT Cs. of TITLE	
LOT. No.	UNIT ENTITLEMENT	VOL.	FOL.	LOT. No.	UNIT ENTITLEMENT	VOL.	FOL.
1	Now re-subdivided			20	45		
2	Now re-subdivided			21	19		
3	Now re-subdivided			22	19		
4	Now re-subdivided			23	81		
5	Now re-subdivided			24	82		
6	Now re-subdivided			25	82		
7	Now re-subdivided			26	111		
8	Now re-subdivided			27	90		
9	Now re-subdivided			28	108		
10	Now re-subdivided			29	67		
11	Now re-subdivided			30	72		
12	Now re-subdivided			31	72		
13	Now re-subdivided						
14	Now re-subdivided						
15	Now re-subdivided						
16	Now re-subdivided						
17	64						
18	64						
19	24			Aggregate	1000		

DESCRIPTION OF PARCEL AND BUILDING/PARCEL

RE-SUBDIVISION OF LOTS 1 TO 6, INCLUSIVE, AND LOTS 8 TO 16, INCLUSIVE, ON STRATA PLAN No. 37612

**CERTIFICATE OF LICENSED VALUER
STRATA**

I, PAUL A. SMITH, being a Licensed Valuer licensed under the *Land Valuers Licensing Act 1978* certify that the unit entitlement of each lot (in this certificate, excluding any common property lots), as stated in the schedule bears in relation to the aggregate unit entitlement of all lots delineated on the plan a proportion not greater than 5 per cent more or 5 per cent less than the proportion that the value (as that term is defined in section 14(2a) of the *Strata titles act 1985*) of that lot bears to the aggregate value of all the lots delineated on the plan.

.....
Date

.....
Signed

PROPOSED STRATA ONLY STAGE THREE

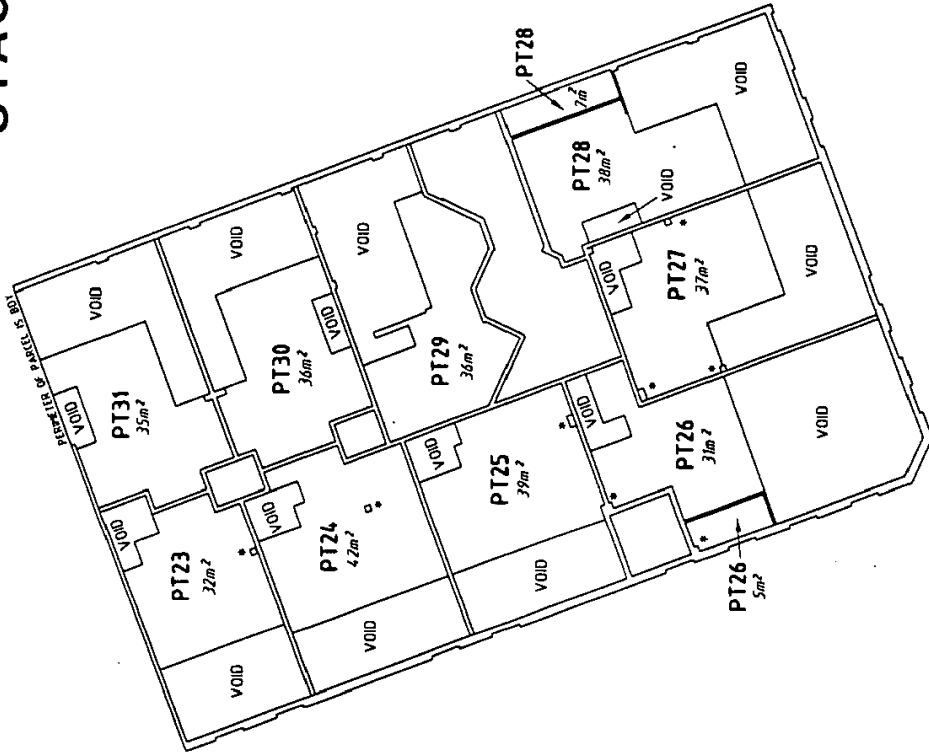

MEZZANINE LEVEL

WARNING: CREASING OR FOLDING WILL LEAD TO REJECTION

STRATA/SUBJECT
 STRATA PLAN
 SHEET 4 OF 4 SHEETS

THE STRATUM OF LOTS 23-31 INCLUSIVE ON THE MEZZANINE FLOOR EXTENDS BETWEEN THE UPPER SURFACE OF THE MEZZANINE FLOOR SLAB TO THE UNDERSIDE OF THE ROOF STRUCTURE.

THE BOUNDARY OF THE LOTS OR PART LOTS WHICH ARE SHOWN ON THE STRATA PLAN IS THE CENTRELINE OF DIVIDING WALLS EXCEPT ON ALL EXTERNAL WALLS WHERE THE BOUNDARY EXTENDS 0.1m INTO THE WALL FROM THE INSIDE FACE, OR WHERE OTHERWISE SHOWN.

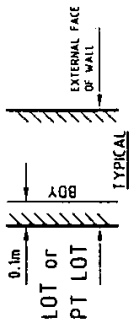

AN * INDICATES A PROPOSED DUCT OR A PROPOSED PILLAR AND THESE ARE EXCLUDED FROM THE UNIT LOT AREA.

ALL ANGLES ARE MULTIPLES OF 45° UNLESS DEFINED BY A PERMANENT STRUCTURE, PERIMETER OF PARCEL OR SHOWN OTHERWISE.

THIS STRATA PLAN IS SUBJECT TO SURVEY AND DERIVED FROM ARCHITECTURAL DRAWINGS ONLY.



PROPOSED STRATA ONLY STAGE THREE

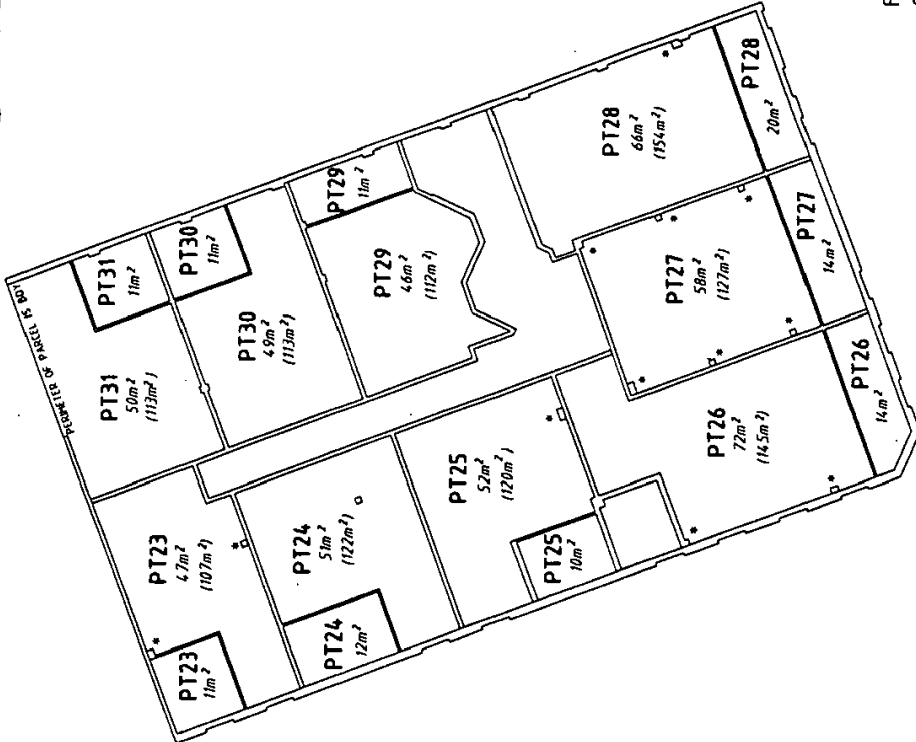
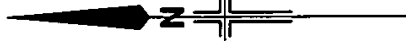

FOR OTHER PART LOTS 23 TO 31 INCLUSIVE
SEE SHEETS 2 AND 4 OF 4 SHEETS

FIRST LEVEL

STRATA/SUBJECT
SEE PLAN
SHEET 3 OF 4 SHEETS

THE STRATA OF LOTS 23-31 INCLUSIVE ON THE FIRST LEVEL EXTENDS BETWEEN THE UPPER SURFACE OF THE FIRST FLOOR SLAB TO THE UNDERSIDE OF THE ROOF STRUCTURE EXCEPT WHERE COVERED BY THE MEZZANINE SLAB (WHERE IT EXTENDS TO THE UNDERSIDE OF THE MEZZANINE SLAB).

THE BOUNDARY OF THE LOTS OR PART LOTS WHICH ARE SHOWN ON THE STRATA PLAN IS THE CENTRELINE OF DIVIDING WALLS EXCEPT ON ALL EXTERNAL WALLS WHERE THE BOUNDARY EXTENDS 0.1m INTO THE WALL FROM THE INSIDE FACE, OR WHERE OTHERWISE SHOWN.

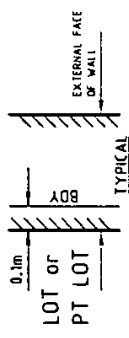

AN * INDICATES A PROPOSED DUCT OR A PROPOSED PILLAR AND THESE ARE EXCLUDED FROM THE UNIT LOT AREA.

ALL ANGLES ARE MULTIPLES OF 45° UNLESS DEFINED BY A PERMANENT STRUCTURE, PERIMETER OF PARCEL OR SHOWN OTHERWISE.

THIS STRATA PLAN IS SUBJECT TO SURVEY AND DERIVED FROM ARCHITECTURAL DRAWINGS ONLY.



ID/EJT 4.8.99
4.614-02-V5 REV C
N011646100V5C01V2V5B.DWG

WARNING: CREASING OR FOLDING WILL LEAD TO REJECTION

PROPOSED STRATA ONLY STAGE THREE

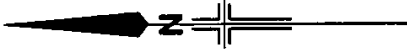

REDUCED



FOR OTHER PART LOTS 23 TO 31 INCLUSIVE
SEE SHEETS 3 AND 4 OF 4 SHEETS

GROUND LEVEL

STRATA/SURVEY

SECTION PLAN

SHEET 2 OF 4 SHEETS

THE STRATUM OF LOTS 17-31 ON THE GROUND FLOOR EXTENDS FROM THE UPPER SURFACE OF GROUND FLOOR SLAB TO THE UNDERSIDE OF THE FIRST FLOOR SLAB OR TO THE UNDERSIDE OF THE SUSPENDED CEILING, WHICH EVER IS APPLICABLE.

THE BOUNDARY OF THE LOTS OR PART LOTS WHICH ARE SHOWN ON THE STRATA PLAN IS THE CENTRELINE OF DIVIDING WALLS EXCEPT ON ALL EXTERNAL WALLS WHERE THE BOUNDARY EXTENDS 0.1m INTO THE WALL FROM THE INSIDE FACE, OR WHERE OTHERWISE SHOWN.

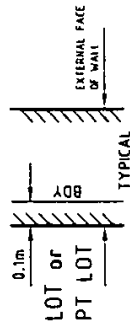

AN * INDICATES A PROPOSED DUCT OR A PROPOSED PILLAR AND THESE ARE EXCLUDED FROM THE UNIT LOT AREA.

ALL ANGLES ARE MULTIPLES OF 45° UNLESS DEFINED BY A PERMANENT STRUCTURE, PERIMETER OF PARCEL OR SHOWN OTHERWISE.

THIS STRATA PLAN IS SUBJECT TO SURVEY AND DERIVED FROM ARCHITECTURAL DRAWINGS ONLY.

F = FACE OF WALL PRODUCED
L = CENTRELINE OF WALL PRODUCED



WARNING: CREASING OR FOLDING WILL LEAD TO REJECTION



JD/EJT 4.8.99
4614-02-V5 REV C
M:\14608028\CAD\BVS\A.DWG

FORM 27

Strata Titles Act 1985

Regulation 37 (1) (a)

STRATA PLAN No. 37612.

CERTIFICATE OF LICENSED VALUER

I, PAUL A. SMITH, being a Licensed Valuer under the *Land Valuers Licensing Act 1978* hereby certify that if a re-subdivision were effected in accordance with a by-law of the strata/survey-strata scheme made under clause 8 of Schedule 2A of the Act, on the basis of information provided in the by-law pursuant to clause 8 (a) of Schedule 2A, a licensed valuer would be able to provide a certificate required under section 14 (2) in respect of the proposed unit entitlement.

15/3/2000
Date

Licensed Valuer

**PROPOSED STRATA ONLY
STAGE THREE**

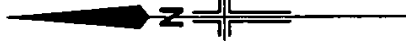

REDUCED

STRATA/SURVEY SCHEME PLAN



JD/EJT 4.8.99
4614-02-V5 REV C
S:\14545786\14545785.DWG

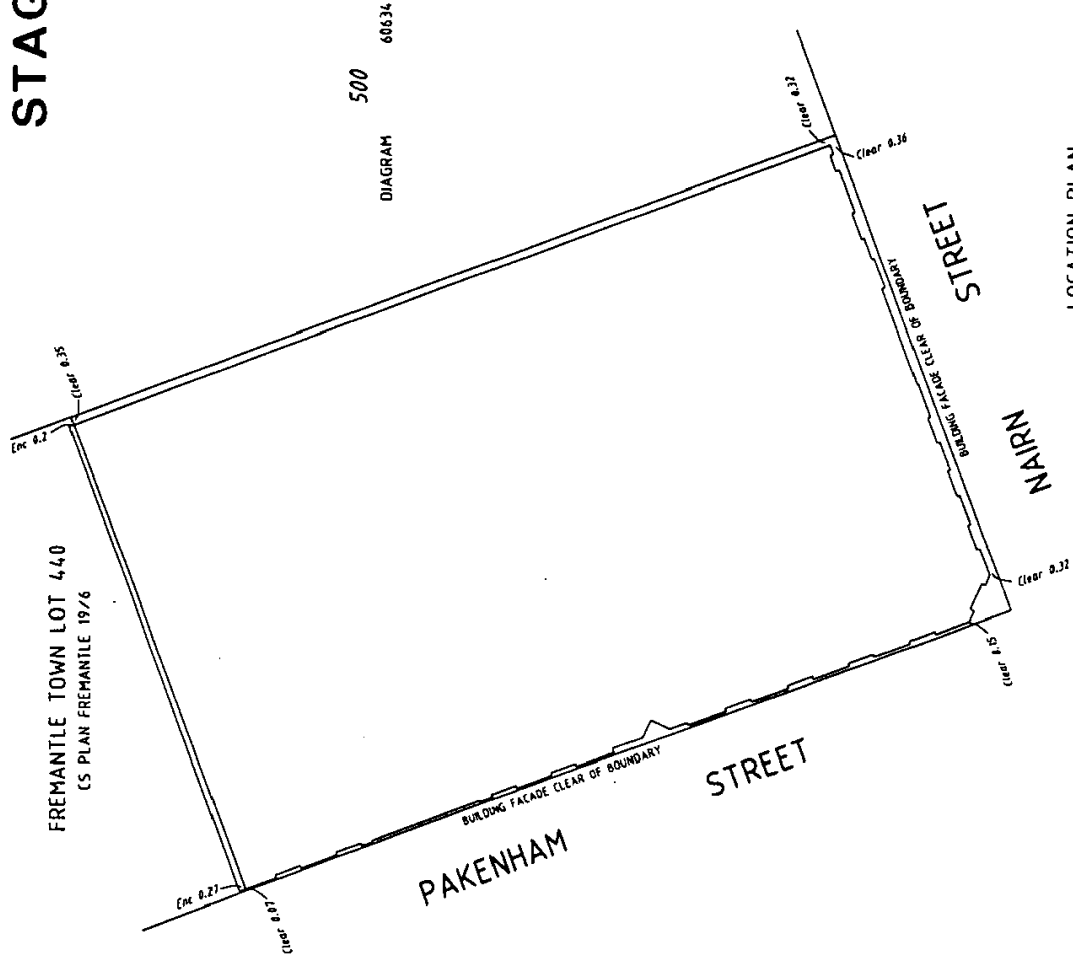

LOCATION PLAN



WARNING: CREASING OR FOLDING WILL LEAD TO REJECTION

STRATA/SURVEY SCHEME PLAN	
SHEET 1 OF 4 SHEETS	
MANAGEMENT STATEMENT	<input checked="" type="checkbox"/> YES <input type="checkbox"/> NO
Lodged.....	
Examined.....	
Registered.....	
REGISTRAR OF TITLES WESTERN AUSTRALIAN PLANNING COMMISSION Certificate of Approval of W.A.P.C. under Section 25(1) or 25B(2) of <i>Strata Titles Act 1985</i>	
FOR CHAIRMAN.....	DATE.....
PLAN OF RE-SUBDIVISION OF LOTS 1-6 & 8-16 INCLUSIVE ON STRATA PLANS FOR STAGES ONE AND TWO RESPECTIVELY.	
CERT. OF TITLE TO BE ISSUED	
LOCAL GOVERNMENT CITY OF FREMANTLE	
INDEX PLAN	6034 (1) 12.25 & 12.26
FIELD BOOK NUMBER	
SCALE	1:200
NAME OF SCHEME	PAKENHAM APARTMENTS
ADDRESS OF PARCEL	No 56 PAKENHAM STREET (cnr. of NAIRN STREET) FREMANTLE WA 6160
 <small>DIVIDED LINE ADDRESS REGULATION</small>	

ANNEXURE OF STRATA PLAN No. 37612

SCHEDULE OF UNIT ENTITLEMENT		OFFICE USE ONLY CURRENT Cs. of TITLE		SCHEDULE OF UNIT ENTITLEMENT		OFFICE USE ONLY CURRENT Cs. of TITLE	
LOT No.	UNIT ENTITLEMENT	VOL.	FOL.	LOT NO.	UNIT ENTITLEMENT	VOL.	FOL.
1	56			10	80		
2	58			11	119		
3	29			12	91		
4	55			13	109		
5	24			14	57		
6	26			15	65		
7	Now re-subdivided			16	65		
8	87						
9	79			Aggregate	1,000		

DESCRIPTION OF PARCEL AND BUILDING/PARCEL

RE-SUBDIVISION OF LOT 7 ON STRATA PLAN 37612

**CERTIFICATE OF LICENSED VALUER
STRATA**

I, PAUL A. SMITH, being a Licensed Valuer licensed under the *Land Valuers Licensing Act 1978* certify that the unit entitlement of each lot (in this certificate, excluding any common property lots), as stated in the schedule bears in relation to the aggregate unit entitlement of all lots delineated on the plan a proportion not greater than 5 per cent more or 5 per cent less than the proportion that the value (as that term is defined in section 14(2a) of the Strata titles act 1985) of that lot bears to the aggregate value of all the lots delineated on the plan.

.....
Date

.....
Signed

PROPOSED STRATA ONLY STAGE TWO

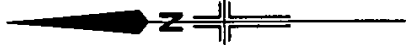

REDUCED

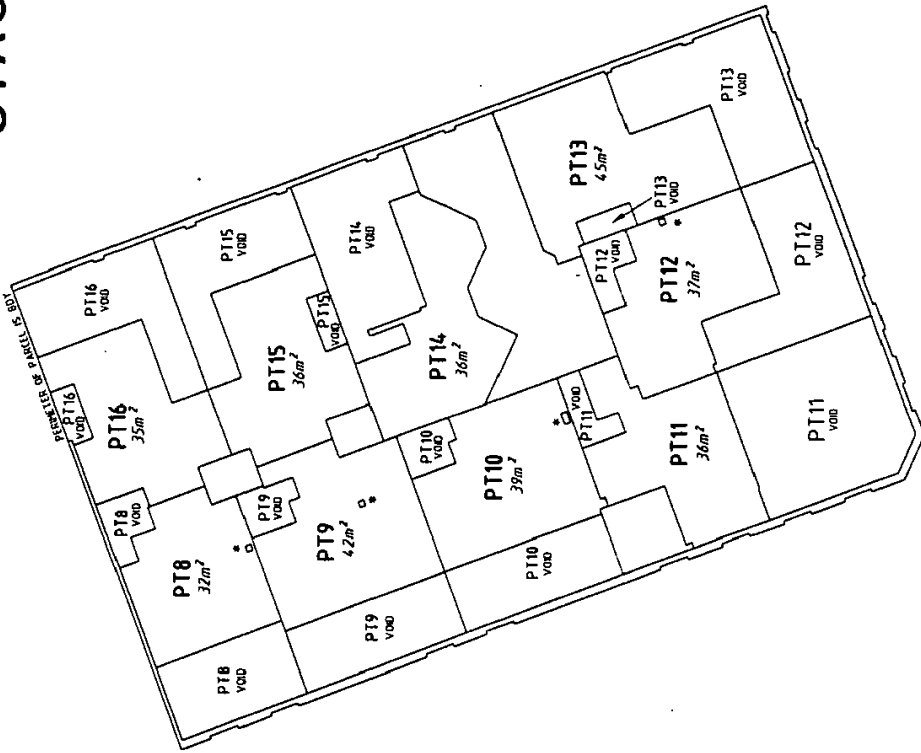

FOR OTHER PART LOTS 8 TO 16 INCLUSIVE
SEE SHEETS 2 AND 3 OF 4 SHEETS

MEZZANINE LEVEL

STRATA/SURVEY
~~SITE~~ PLAN
SHEET 4 OF 4 SHEETS

THE STRATUM OF LOTS 8 TO 16 INCLUSIVE ON THE MEZZANINE LEVEL, EXTENDS FROM 3 METRES ABOVE THE UPPER SURFACE OF THE FIRST FLOOR SLAB TO THE UNDERSIDE OF THE ROOF STRUCTURE.

THE BOUNDARY OF THE LOTS OR PART LOTS WHICH ARE SHOWN ON THE STRATA PLAN IS THE CENTRELINE OF THE PROPOSED DIVIDING WALLS (AS SHOWN BY CONSTRUCTION LINES) EXCEPT ON ALL EXTERNAL WALLS WHERE THE BOUNDARY EXTENDS 0.1m INTO THE WALL FROM THE INSIDE FACE, OR WHERE OTHERWISE SHOWN.

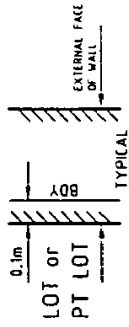

AN * INDICATES A PROPOSED DUCT OR A PROPOSED PILLAR AND THESE ARE EXCLUDED FROM THE UNIT LOT AREA.

ALL ANGLES ARE MULTIPLES OF 45° UNLESS DEFINED BY A PERMANENT STRUCTURE, PERIMETER OF PARCEL OR SHOWN OTHERWISE.

THIS STRATA PLAN IS SUBJECT TO SURVEY AND DERIVED FROM ARCHITECTURAL DRAWINGS ONLY.

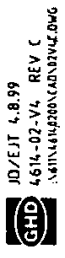

WARNING: CREASING OR FOLDING WILL LEAD TO REJECTION



PROPOSED STRATA ONLY STAGE TWO

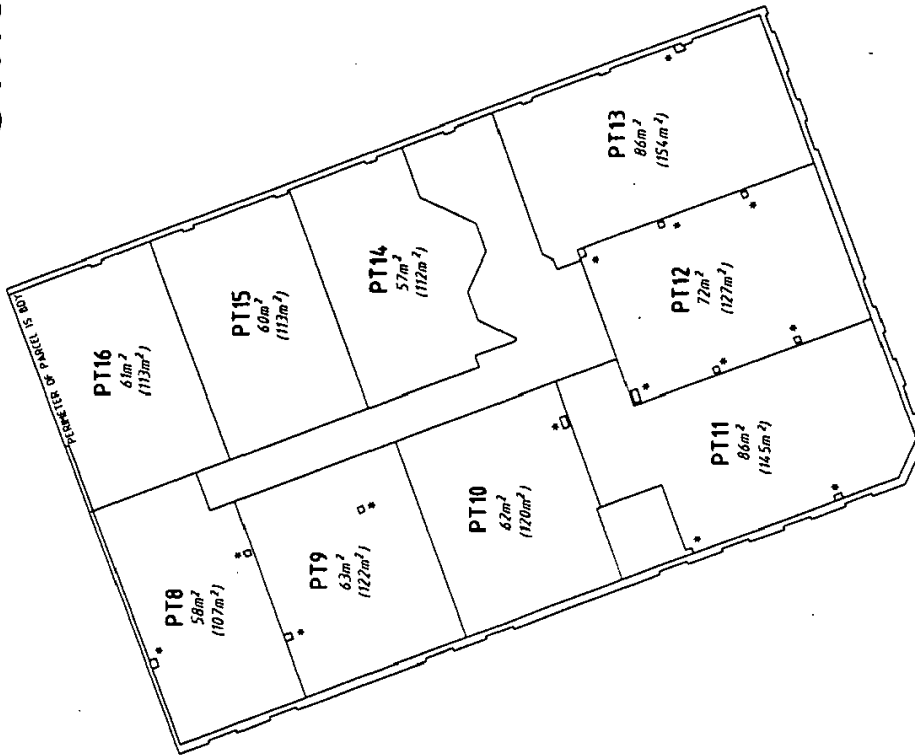

FIRST LEVEL

THE STRATUM OF LOTS 8 TO 16 INCLUSIVE ON THE FIRST LEVEL EXTENDS FROM THE UPPER SURFACE OF THE FIRST FLOOR SLAB TO THE UNDERSIDE OF THE EXISTING ROOF STRUCTURE EXCEPT WHERE IT INTERSECTS THE MEZZANINE FLOOR AS DESCRIBED IN PLAN VIEW ON SHEET 4 OF 4 SHEETS.

THE BOUNDARY OF THE LOTS OR PART LOTS WHICH ARE SHOWN ON THE STRATA PLAN IS THE CENTRELINE OF THE PROPOSED DIVIDING WALLS (AS SHOWN BY CONSTRUCTION LINES) EXCEPT ON ALL EXTERNAL WALLS WHERE THE BOUNDARY EXTENDS 0.1m INTO THE WALL FROM THE INSIDE FACE, OR WHERE OTHERWISE SHOWN.

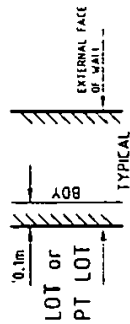

AN * INDICATES A PROPOSED DUCT OR A PROPOSED PILLAR AND THESE ARE EXCLUDED FROM THE UNIT LOT AREA.

ALL ANGLES ARE MULTIPLES OF 45° UNLESS DEFINED BY A PERMANENT STRUCTURE. PERIMETER OF PARCEL OR SHOWN OTHERWISE.

THIS STRATA PLAN IS SUBJECT TO SURVEY AND DERIVED FROM ARCHITECTURAL DRAWINGS ONLY.



REDUCED

FOR OTHER PART LOTS 8 TO 16 INCLUSIVE
SEE SHEETS 2 AND 4 OF 4 SHEETS

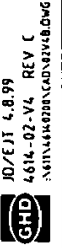

WARNING: CREASING OR FOLDING WILL LEAD TO REJECTION

STRATA/SURVEY

STRATA PLAN

SHEET 3 OF 4 SHEETS

STRATA/SUBDIVISION
GENERAL PLAN
 SHEET 2 OF 4 SHEETS

PROPOSED STRATA ONLY STAGE TWO

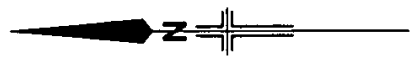

REDUCED

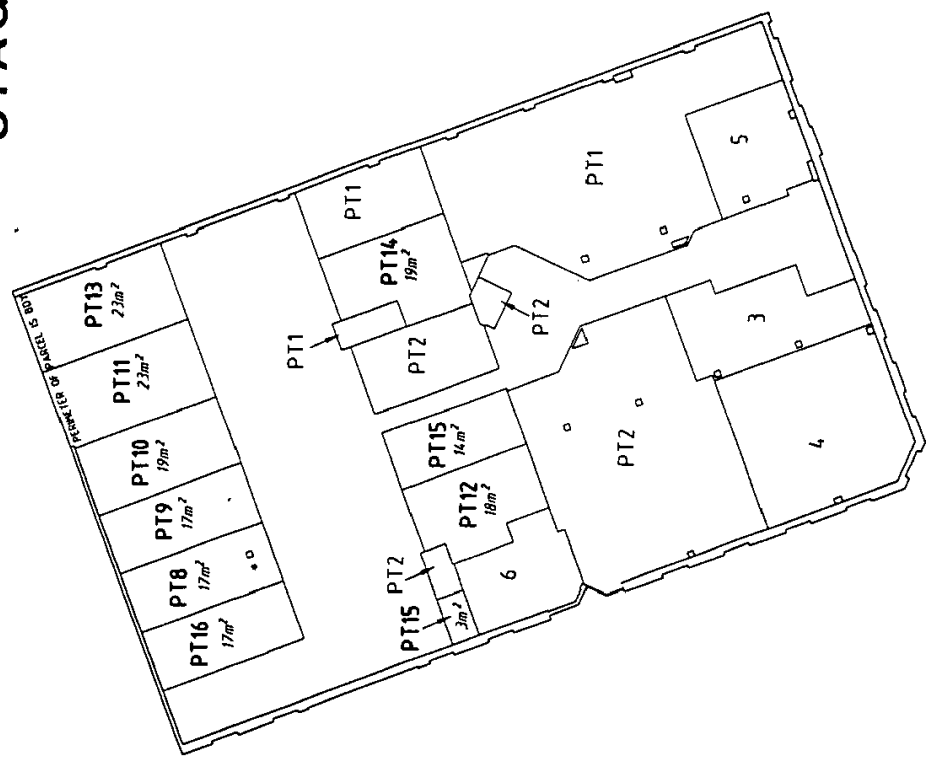

THE STRATUM OF LOTS 1-6 AND 8-16 INCLUSIVE ON THE GROUND LEVEL EXTENDS FROM THE LOWEST LEVEL OF THE UPPER-SURFACE OF THE FLOOR SLAB ON THE GROUND LEVEL TO THE UNDERSIDE OF THE FIRST LEVEL FLOOR SLAB.

THE BOUNDARY OF THE LOTS OR PART LOTS WHICH ARE SHOWN ON THE STRATA PLAN IS THE CENTRELINE OF THE PROPOSED DIVIDING WALLS (AS SHOWN BY CONSTRUCTION LINES) EXCEPT ON ALL EXTERNAL WALLS WHERE THE BOUNDARY EXTENDS 0.1m INTO THE WALL FROM THE INSIDE FACE, OR WHERE OTHERWISE SHOWN.

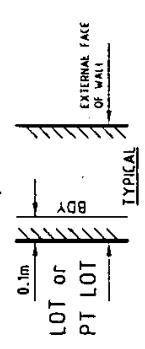

AN * INDICATES A PROPOSED DUCT OR A PROPOSED PILLAR AND THESE ARE EXCLUDED FROM THE UNIT LOT AREA.

ALL ANGLES ARE MULTIPLES OF 45° UNLESS DEFINED BY A PERMANENT STRUCTURE, PERIMETER OF PARCEL OR SHOWN OTHERWISE.

THIS STRATA PLAN IS SUBJECT TO SURVEY AND DERIVED FROM ARCHITECTURAL DRAWINGS ONLY.

PT LOTS 1-6 SHOWN AS ABUTTALS ON THIS STRATA PLAN AND CREATED ON STRATA PLAN FOR STAGE ONE.



FOR OTHER PART LOTS 8 TO 16 INCLUSIVE
 SEE SHEETS 3 AND 4 OF 4 SHEETS.

GROUND LEVEL



JD/EJT 4.8.99
 4.614-02-V4 REV C
 N:\11464878\GHD\030707.dwg

WARNING: CREASING OR FOLDING WILL LEAD TO REJECTION

REDUCED

FORM 1

PROPOSED STRATA ONLY STAGE TWO

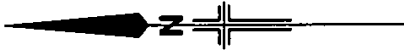

STRATA SURVEY STRATA PLAN

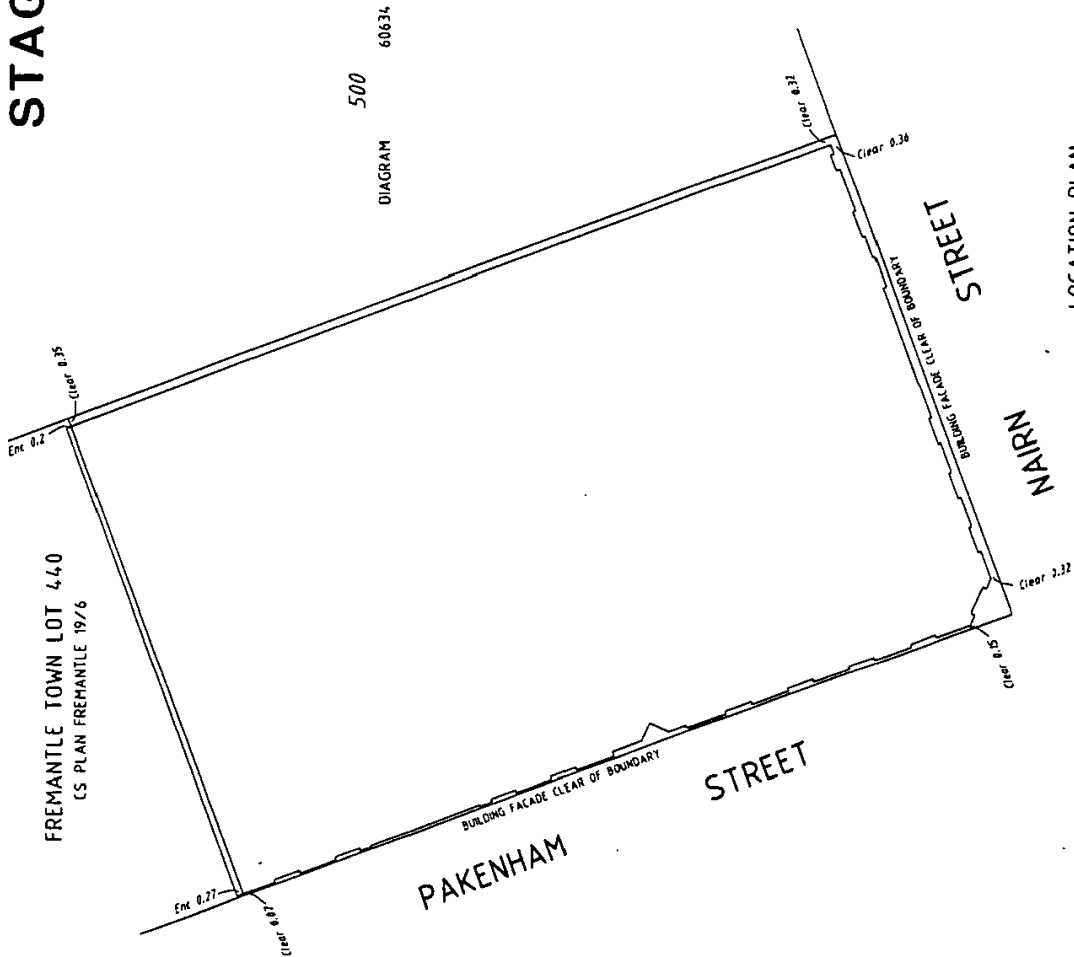
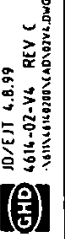

LOCATION PLAN

WARNING: CREASING OR FOLDING WILL LEAD TO REJECTION

STRATA/SURVEY PLAN	
SHEET 1 OF 4 SHEETS	
MANAGEMENT STATEMENT	<input checked="" type="checkbox"/> YES <input type="checkbox"/> NO
Lodged.....	
Examined.....	
Registered.....	
REGISTRAR OF TITLES WESTERN AUSTRALIAN PLANNING COMMISSION Certificate of Approval of W.A.P.C. under Section 25(1) or 25B(2) of <i>Strata Titles Act 1985</i>	
FOR CHAIRMAN.....	DATE.....
PLAN OF RE-SUBDIVISION OF LOT 7 ON STRATA PLAN FOR STAGE ONE	
CERT. OF TITLE TO BE ISSUED	
LOCAL GOVERNMENT CITY OF FREMANTLE	
INDEX PLAN BG34 (1) 12.25 & 12.26	
FIELD BOOK NUMBER	
SCALE	1:200
NAME OF SCHEME PAKENHAM APARTMENTS	
ADDRESS OF PARCEL No 56 PAKENHAM STREET (Cnr. of NAIRN STREET) FREMANTLE WA 6160	

FORM 7

Strata Titles Act 1985

Section 5B(2), 8A(f), 23(1)

STRATA PLAN No. 37612

DESCRIPTION OF PARCEL & BUILDING

PARCEL : FREMANTLE TOWN LOT 441. THE ADDRESS OF THE PARCEL IS No. 56 PAKENHAM STREET, FREMANTLE WA 6160
BUILDING : THE BUILDING ON THE PARCEL IS A BRICK AND CONCRETE CONSTRUCTION.

CERTIFICATE OF LOCAL GOVERNMENT

CITY OF FREMANTLE, the local government hereby certifies that in respect of the strata plan which relates to the parcel and building described above (in this certificate called "the plan"):-

- (1) *(a) the building and the parcel shown on the plan have been inspected and that it is consistent with the approved building plans and specifications in respect of the building; or
*(b) the building has been inspected and the modification is consistent with the approved building plans and specifications relating to the modification;
(2) the building, in the opinion of the local government, is of sufficient standard to be brought under the Strata Titles Act 1985;
(3) where a part of a wall or building or material attached to a wall or building, encroaches beyond the external surface boundaries of the parcel on to a public road, street or way the local government is of the opinion that retention of the encroachment in its existing state will not endanger public safety or unreasonably interfere with the amenity of the neighbourhood and the local government does not object to the encroachment; and
(4) *(a) any conditions imposed by the Western Australian Planning Commission have been complied with; or
*(b) the within strata scheme is exempt from the requirement of approval by the Western Australian Planning Commission.

25/2/2000
Date

[Signature]
Chief Executive Officer

*Delete if inapplicable

DIRECTOR, URBAN MANAGEMENT

FORM 5

STRATA PLAN No. 37612

DESCRIPTION OF PARCEL & BUILDING

PARCEL : FREMANTLE TOWN LOT 441. THE ADDRESS OF THE PARCEL IS No. 56 PAKENHAM STREET FREMANTLE WA 6160
BUILDING : THE BUILDING ON THE PARCEL IS A BRICK AND CONCRETE CONSTRUCTION

CERTIFICATE OF LICENSED SURVEYOR

I, PAUL LEE BEAVER, being a licensed surveyor registered under the Licensed Surveyors Act 1909, certify that in respect of the strata plan which relates to the parcel and building described above (in this certificate called "the plan")—

- (a) each lot that is not wholly within a building shown on the plan is within the external surface boundaries of the parcel; and either
(b) each building shown on the plan is within the external surface boundaries of the parcel; or
(c) in a case where a part of a wall or building, or material attached to a wall or building, encroaches beyond the external surface boundaries of the parcel—
(i) all lots shown on the plan are within the external surface boundaries of the parcel;
(ii) the plan clearly indicates the existence of the encroachment and it's nature and extent; and
(iii) where the encroachment is not on to a public road, street or way, that an appropriate easement has been granted and will be lodged with the Registrar of Titles to enable it to be registered as an appurtenance of the parcel; and

* (d) if the plan is a plan of re-subdivision, it complies with Schedule 1 by law(s) No(s) on Strata Plan No registered in respect of (name of scheme) or sufficiently complies with that/those by law(s) in a way that is allowed by regulation 36 of the Strata Titles General Regulations 1996.

28-2-00

Date

Handwritten signature of Paul Lee Beaver

Licensed Surveyor

* Delete if inapplicable

col 52 / 2000 vol 3 p 33

ANNEXURE A OF STRATA PLAN No. 37612

SCHEDULE OF UNIT ENTITLEMENT		OFFICE USE ONLY CURRENT Cs. of TITLE		SCHEDULE OF UNIT ENTITLEMENT		OFFICE USE ONLY CURRENT Cs. of TITLE	
LOT. No.	UNIT ENTITLEMENT	VOL.	FOL.	LOT NO.	UNIT ENTITLEMENT	VOL.	FOL.
1	56			6	26		
2	58			7	752		
3	29						
4	55						
5	24			Aggregate	1,000		

DESCRIPTION OF PARCEL AND BUILDING/PARCEL

FREMANTLE TOWN LOT 441.

**CERTIFICATE OF LICENSED VALUER
STRATA**

I, PAUL A. SMITH, being a Licensed Valuer licensed under the *Land Valuers Licensing Act 1978* certify that the unit entitlement of each lot (in this certificate, excluding any common property lots), as stated in the schedule bears in relation to the aggregate unit entitlement of all lots delineated on the plan a proportion not greater than 5 per cent more or 5 per cent less than the proportion that the value (as that term is defined in section 14(2a) of the *Strata titles act 1985*) of that lot bears to the aggregate value of all the lots delineated on the plan.

.....
Date 2/3/2000.....

.....
Signed

STRATA/SUBDIVISION
 SUBDIVISION PLAN 37612
 SHEET 4 OF 4 SHEETS

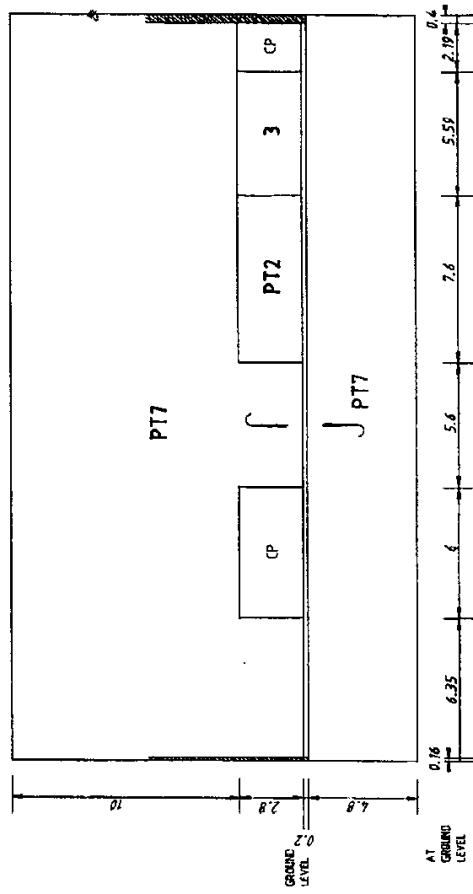
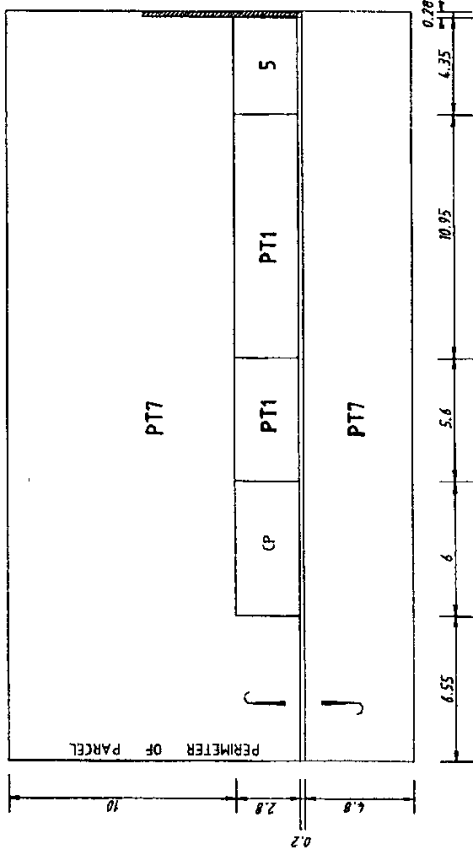

NOTE:
 1. CP = COMMON PROPERTY

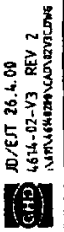

WARNING: CREASING OR FOLDING WILL LEAD TO REJECTION

FORM 4

STRATA/SUBDIVISION
GERBERA PLAN 37612
 SHEET 3 OF 4 SHEETS

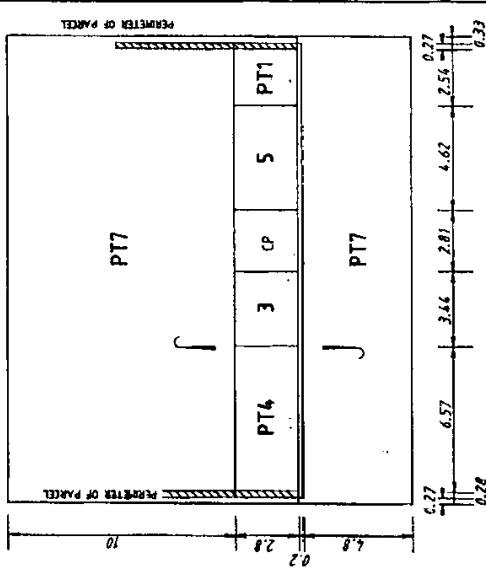

SECTION C-C

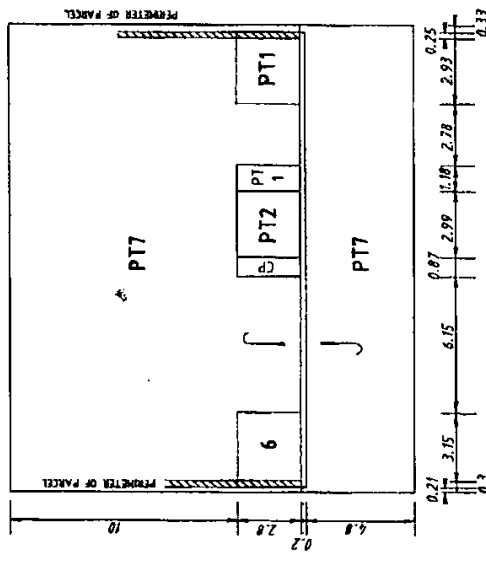

SECTION B-B

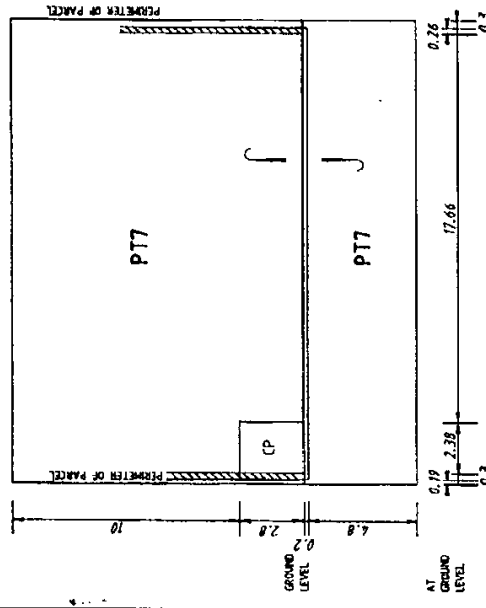

SECTION A-A

NOTE:
 1. CP = COMMON PROPERTY

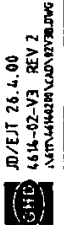

WARNING: CREASING OR FOLDING WILL LEAD TO DEFECTION



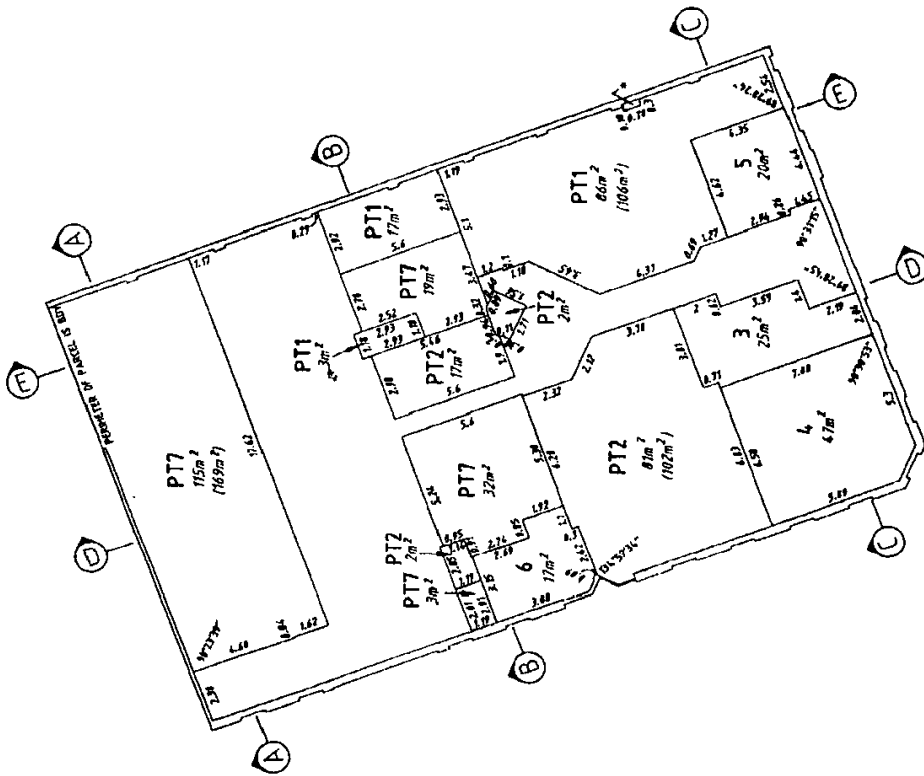

FOR CROSS SECTIONS A-A, B-B AND C-C
SEE SHEET 3 OF 4 SHEETS.
FOR CROSS SECTIONS D-D AND E-E
SEE SHEET 4 OF 4 SHEETS.

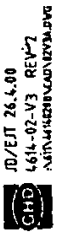

STRATA/SURVEY

SEEKERS PLAN

SHEET 2 OF 4 SHEETS

THE STRATUM OF LOTS 1 TO 6 INCLUSIVE ON THE GROUND LEVEL, EXTENDS FROM THE LOWEST LEVEL OF THE UPPER SURFACE OF THE FLOOR SLAB ON THE GROUND LEVEL TO 2.8m ABOVE THE LOWEST LEVEL OF THE UPPER SURFACE OF THE FLOOR SLAB ON THE GROUND LEVEL.

THE STRATUM OF PART LOTS 7 EXTENDS FROM 5m BELOW THE LOWEST LEVEL OF THE UPPER SURFACE OF THE FLOOR SLAB ON THE GROUND LEVEL TO 12.8m ABOVE THE UPPER SURFACE OF THE FLOOR SLAB ON THE GROUND LEVEL, EXCEPT WHERE ABOVE LOTS 1 TO 6 INCLUSIVE, WHERE THE STRATUM EXTENDS FROM 2.8m ABOVE THE LOWEST LEVEL OF THE UPPER SURFACE OF THE FLOOR SLAB ON THE GROUND LEVEL TO 12.8m ABOVE THE LOWEST LEVEL OF THE UPPER SURFACE OF THE FLOOR SLAB ON THE GROUND LEVEL.

THE BOUNDARY OF THE LOTS OR PART LOTS WHICH ARE SHOWN ON THE STRATA PLAN IS THE CENTRELINE OF THE PROPOSED DIVIDING WALLS (AS SHOWN BY DIMENSIONS) EXCEPT ON ALL EXTERNAL WALLS WHERE THE BOUNDARY EXTENDS 0.1m INTO THE WALL FROM THE INSIDE FACE, OR WHERE OTHERWISE SHOWN, AS PROVIDED BY SECTION 3(2)(b) OF THE STRATA TITLES ACT 1985.

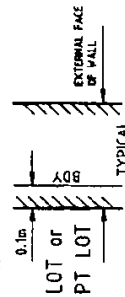

AN * INDICATES A PROPOSED DUCT OR A PROPOSED PILLAR AND THESE ARE EXCLUDED FROM THE UNIT LOT AREA.

ALL ANGLES ARE MULTIPLES OF 45° UNLESS DEFINED BY A PERMANENT STRUCTURE, PERIMETER OF PARCEL OR SHOWN OTHERWISE.

GROUND LEVEL



WARNING: CREASING OR FOLDING WILL LEAD TO REFLECTION

Cor 52 / 2000 Vol 3 p 33

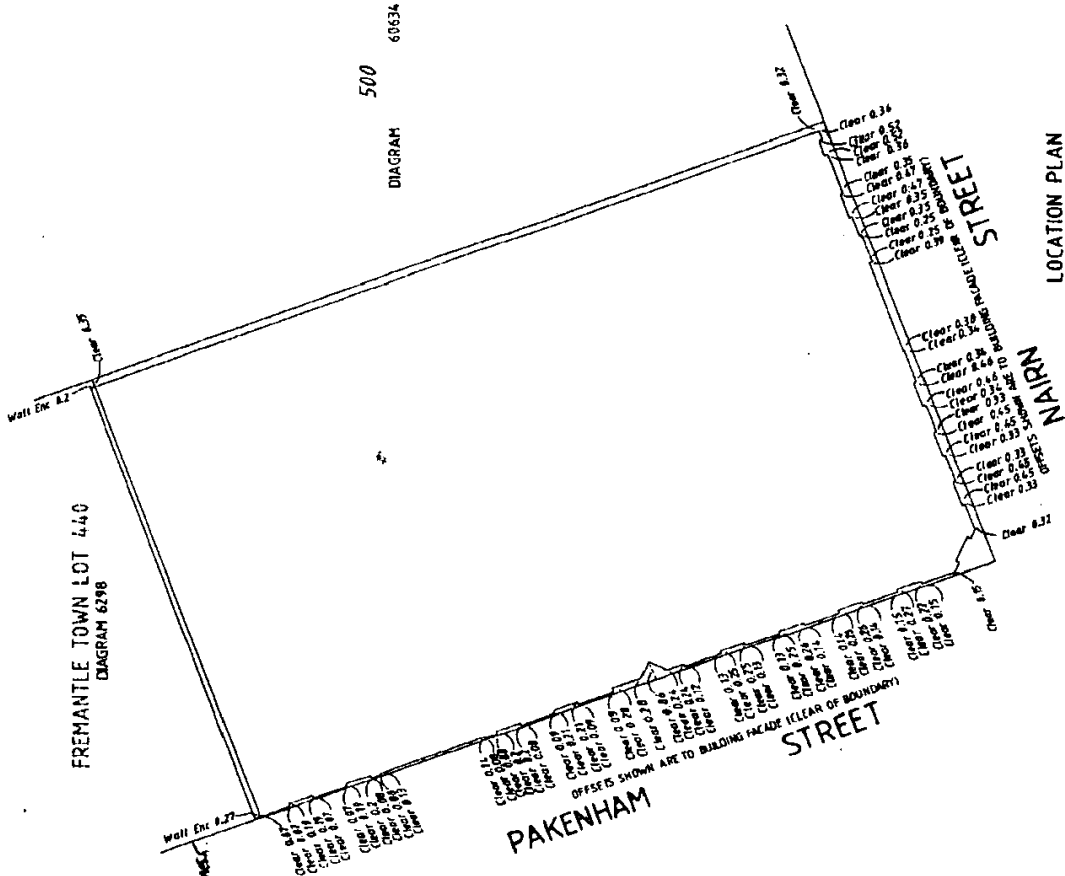
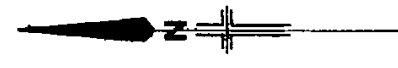

LOCATION PLAN



WARNING: CREASING OR FOLDING WILL LEAD TO REJECTION

STRATA/SUBDIVISION STRATA PLAN 37612	
SHEET 1 OF 4 SHEETS	
MANAGEMENT STATEMENT <input checked="" type="checkbox"/> YES <input type="checkbox"/> NO	
Lodged 3.3.2000 <i>Repeal</i> Examined 27.4.2000 <i>OK</i>	
Registered POWDS ① LODGEMENT OF MANAGEMENT STATEMENT ② EXTENSION OVER DIAGRAM 6298.	
REGISTRAR OF TITLES WESTERN AUSTRALIAN PLANNING COMMISSION Certificate of Approval of W.A.P.C. under Section 24(1) or 25(B2) of Strata Titles Act 1985	
FOR CHAIRMAN DATE 1.2.00	
PLAN OF FREMANTLE TOWN LOT 441	
CERT. OF TITLE VOL 1502 FOL 185	
LOCAL GOVERNMENT CITY OF FREMANTLE	
INDEX PLAN BG34, (1) 12.25 & 12.26	
FIELD BOOK NUMBER	
SCALE 1:200	
NAME OF SCHEME PAKENHAM APARTMENTS	
ADDRESS OF PARCEL No 56 PAKENHAM STREET (COR. OF NAIRN STREET) FREMANTLE WA 6160	

COE 52/2000 Vol 3 P 33

ITEM No. 1 IN SCHEDULE

COPY OF INITIAL STRATA PLAN AND PROPOSED STRATA PLANS OF RE-SUBDIVISION FOR THE STAGES OF THE DEVELOPMENT REFERRED TO IN SCHEDULE 1 BY-LAW 26 AND 27 TOGETHER WITH THE PROPOSED SCHEDULES OF UNIT ENTITLEMENT FOR EACH OF THE STAGES AND CERTIFICATES OF A LICENSED VALUER IN ACCORDANCE WITH ITEM 8 (a) OF SCHEDULE 2A AND REGULATION 37 (1) (a) OF THE ACT FOR THE RE-SUBDIVISIONS OF THE STRATA PLAN.

SCHEDULE TO MANAGEMENT STATEMENT

CONTENTS

ITEM No.

- 1. COPY OF INITIAL STRATA PLAN AND PROPOSED STRATA PLANS OF RE-SUBDIVISION FOR THE STAGES OF THE DEVELOPMENT REFERRED TO IN SCHEDULE 1 BY-LAW 26 AND 27 TOGETHER WITH THE PROPOSED SCHEDULES OF UNIT ENTITLEMENT FOR EACH OF THE STAGES AND CERTIFICATES OF A LICENSED VALUER IN ACCORDANCE WITH ITEM 8 (a) OF SCHEDULE 2A AND REGULATION 37 (1) (a) OF THE ACT FOR THE RE-SUBDIVISIONS OF THE STRATA PLAN.**

- 2. STRATA COMPANY MANAGEMENT AGREEMENT REFERRED TO IN SCHEDULE 2 BY-LAW No. 18.**

- 3. CONSTRUCTION PLANS FOR THE BUILDING WORKS.**

SIGNED BY PERSONS HAVING REGISTERED INTERESTS AND CAVEATORS (IF ANY)
ENCUMBRANCE Document & No.:

Mortgage H337241 to National Australia Bank Ltd.

Executed by NATIONAL AUSTRALIA BANK
LIMITED A.C.N. 004 044 937 by being
signed in Western Australia by its
Attorney *DAVID DOUGLAS HAROLD LOW*
under Power of Attorney No. 22355
(who declares that he
is at the office in the Bank indicated
under his signature) in the presence of:
Annithale
Clerk to the said Bank

NATIONAL AUSTRALIA BANK LIMITED
By its Attorney

[Signature]
MANAGER BUSINESS BANKING & SECURITIES

18. The Strata Company Management Agreement.

The management agreement between the Strata Company and the Strata Company Manager will be in the same form and context, contain the same expressed meanings and terms of appointment of the Strata Company Manager as are contained in the Strata Company Management Agreement contained in the Schedule hereto, that forms part of this by-law, unless varied in accordance with Schedule 2 by-law 19.

19. Variation of the Strata Company Management Agreement.

The terms, conditions, delegation of responsibilities of the duties and powers of the Strata Company contained within the Strata Company Management Agreement, specified in Schedule 2 by-law 18, may only be varied by a majority resolution of the Strata Company, an order of the Strata Titles Referee or the Supreme Court, as provided for in the Act.

20. Termination of the Strata Company Management Agreement.

The Strata Company may only terminate an agreement with a Strata Company Manager by a majority resolution passed at a duly convened general meeting of the Strata Company and must have prior to such majority resolution to terminate such agreement have resolved by a majority at a duly convened general meeting of the Strata Company to enter into a further agreement with another Strata Company Manager that shall contain the same terms, conditions, delegation of responsibilities, duties and powers of the Strata Company as where contained in the previous Strata Company Management Agreement, unless varied in accordance with Schedule 2 by-law 19.

WARNING

The proposed re-subdivision in Schedule 1 by-laws 26 and 27 is not binding on the Western Australian Planning Commission, local government or any other public or statutory authority. Any of these authorities may not approve, or may require changes before approving, the proposed re-subdivision.

DATED THIS 1st DAY OF May 2000.

SIGNATURE OF APPLICANT:

The Common Seal of **INVESTMENT CLUB PTY LTD** (ACN 078 127 536) was hereunto affixed in the presence of:

D. Cordic
Director.

[Signature]
Director/Secretary



~~EXECUTED BY~~
~~The Common Seal of KAVILLA PTY LTD (ACN 078 851 742)~~
~~was hereunto affixed in the presence of:~~

[Signature]
Director. Geoff Buckley Aulvgame

[Signature]
Director/Secretary.
DAVID WARREN PRINGLE

- (c) Should any leakage, seepage or transference of any water or liquid from the wet areas of a lot or lots to another lot or lots, any part of the common property or the building occur the Strata Company shall give notice, in writing, to the registered proprietor of the lot or lots from which the leakage, seepage or transference originates to rectify such leakage, seepage or transference.
- (d) Should the registered proprietor of the offending lot or lots not, within a time specified by the Strata Company for the rectification to be carried out carry out such works as may be required then the Strata Company may in accordance with sections 38 and 39 of the Act employ whatever means may be necessary to rectify such leakage, seepage or transference.
- (e) Should the Strata Company take action in accordance with clause (d) of this by-law then any and all costs incurred by the Strata Company in rectifying such leakage, seepage or transference shall be payable by the registered proprietor of the offending lot or lots to the strata company and may be recovered by the Strata Company in accordance with section 38 of the Act.
- (f) Should any leakage, seepage or transference of water or liquid be found to be due to a fault or defect in any part of the common property then this by-law will have no effect other than to those powers conferred on the Strata Company pursuant to sections 38 and 39 of the Act.

14. Vermin, pest and insects.

A proprietor shall keep his or her lot clean and shall take all practicable steps to prevent infestation by vermin, pests and insects.

15. Garbage disposal.

A proprietor, occupier or tenant of a lot shall:-

- (a) maintain within his or her lot, or on such part of the common property as may be authorised by the Strata Company, in clean and dry condition and adequately covered, a receptacle for garbage;
- (b) ensure that before refuse is placed in the receptacle that it is securely wrapped or in the case of tins, bottles and other containers is completely drained;
- (c) comply with all local government authority by-laws and ordinances relating to the disposal of garbage;
- (d) ensure that the health, hygiene and comfort of the proprietor, occupier or tenant of any other lot is not adversely affected by his or her disposal of garbage.

16. Signage erection and installation within the scheme.

- (a) The Strata Company may make rules, standards and specifications for the erection, installation, painting and affixing of signage contained within the lots and the parcel.
- (b) No sign will be erected, installed, painted or affixed within a lot or the parcel without the prior written consent of the Council of the Strata Company or the Strata Company Manager and such consent will not be unreasonably withheld.

17. Employment of the Strata Company Manager.

The Strata Company may employ the services of a Strata Company Manager for the purposes of administering the affairs of the Strata Company in respect to all of the responsibilities and obligations of the Strata Company as contained in sections 35, 35A and 36 (1) of the Act and to also perform those other duties of the Strata Company as contained in section 36 (2) of the Act together with exercising the powers of the Strata Company in accordance with section 37 of the Act and Schedule 1 by-law 8 (2) (b), as may be required from time to time, and the Strata Company may enter into an agreement with a Strata Company Manager for these purposes.

8. Weight loads to floors.

A proprietor, occupier or tenant of a lot shall not do any act or thing or permit any person to do any act or thing which might result in excessive stress or floor loading to any part of his or her lot or the common property and, without limitation, not allow a weight loading on any part of his or her lot of more than that specified in the engineer's specifications for that lot.

9. Appearance of the lot.

A proprietor, occupier or tenant of a lot shall maintain the appearance of the lot in such a manner that it is in keeping with the appearance of the other lots within the scheme in respect to tidiness and landscaping contained within the lot and shall not:-

- (a) display any sign, advertising, placard, banner, pamphlet or like matter on any external part of his or her lot;
- (b) maintain within the lot anything visible from outside the lot that, when viewed from outside the lot, is not in keeping with the rest of the building;
- (c) permit any tree, shrub or other plant contained within his or her lot, external to the building to exceed a height of 4 metres or grow in a manner such that it restricts the outlook from any other lot or encroaches into any other lot.

10. Maintenance of services and parts of the building contained within a lot.

The cost of any maintenance, repair or replacement of any part of the building, sewerage plumbing, water supply pipes, gas piping, electrical supply wiring and any other service supply contained within the boundaries of the individual lot, beyond any common supply connection point contained within the parcel shall be the sole responsibility of the registered proprietor of the lot to which such maintenance, repair or replacement is required.

11. Maintenance and repair of dividing fences or walls.

It is the responsibility of each registered proprietor to ensure that any dividing fence or wall between their relevant lot and any other lot is properly maintained and repaired as the need may arise and any costs incurred shall be the responsibility of the registered proprietors of the lots to which the fence relates and such costs will be divided between the registered proprietors of the lots concerned in accordance with the Dividing Fences Act. 1961, as amended.

12. Blockage of drainage pipes.

The water closets, conveniences and other water apparatus including waste pipes and drains shall not be used for any purpose other than those for which they were constructed and no sweepings or rubbish or other unsuitable substance shall be deposited therein. Any damage or blockage resulting to such water closets, conveniences, water apparatus, waste pipes and drains from misuse or negligence shall be borne by the proprietor whether the same is caused by his or her own actions or those of his or her tenants servants agents invitees or licensees.

13. Water leakage to other lots or common property.

- (a) It is the responsibility of the registered proprietor or occupier of a lot to ensure that all wet areas, such as bathrooms, en-suites, toilets, laundries, kitchens and balconies, contained within the lot or lots of which they are the registered proprietor or occupier are maintained in a proper sealed manner so as to prevent the leakage, seepage or transference of any water or other liquid to any part of the common property, other than waste pipes provided for the disposal of such water or liquid, or to any other lot or part of the building.
- (b) Should any leakage, seepage or transference of any water or liquid from the wet areas of a lot or lots to another lot or lots, any part of the common property or the building occur it is the responsibility of the registered proprietor to rectify such leakage, seepage or transference of such water or liquid and the cost of such rectification shall be the responsibility of the registered proprietor of the lot or lots from which the leakage, seepage or transference has occurred.

- (j) make undue noise in or about any lot or common property that contravenes any regulation, by-law or statute of the local government authority or any other government or regulating authority law;
- (k) keep any animals on the lot that he or she owns, occupies, leases or rents or the common property after notice in that behalf given him or her by the Council;
- (l) permit any child of whom he or she has control to play upon common property within the scheme, or unless accompanied by an adult exercising effective control, to be or to remain upon common property comprising an access road, car parking area or other area of possible danger or hazard to children;
- (m) use language or behave in a manner likely to cause offence or embarrassment to the proprietor, occupier or tenant of another lot or to any person lawfully using common property and shall be adequately clothed when upon common property;
- (n) use or store on the lot or upon the common property any inflammable chemicals, liquid or gas or other inflammable material, other than a fuel tank of a motor vehicle or internal combustion engine;
- (o) alter the structure of the lot or gas, electrical, water or sewerage installation except as may be permitted and provided for under the Act and by-laws, before commencement of the alteration;
- (p) install any machinery or air conditioning plant within any lot so that part of that machinery or plant projects into common property.

3. Use of common property.

Except with the approval of the Strata Company, a proprietor, occupier, or tenant of a lot shall not:-

- (a) damage any lawn, garden, tree, shrub, plant or flower upon common property; or
- (b) use any portion of the common property for his or her own purposes.

4. Alterations to common property.

The facilities, amenities, services and common property included in the original construction plans and building specification approved by the local government authority will not be changed or altered in any manner so as to delete any item aforesaid from the scheme and the Strata Company will ensure that all such facilities, amenities, services and common property are properly maintained and where necessary replaced should their proper function be beyond repair.

5. Damage to common property.

Should any damage whatsoever be caused to any part of the common property by any proprietor, its tenants, servants, agents, invitees, licensees or contractors then that proprietor shall be solely responsible for the costs of making good such damage.

6. Instructing of contractors by proprietors.

A proprietor shall not directly instruct any contractors or workmen employed by the Strata Company unless so authorised. Any proprietor instructing any contractor or workmen without authorisation from the Strata Company shall be responsible personally for the payment of such contractor or workmen and shall be further personally responsible for the cost of removing or altering any such work which the Strata Company deems unsatisfactory.

7. Costs of making good any damage.

If the Strata Company expends money to make good damage caused by a breach of the Act or of the by-laws by any proprietor or his or her tenants, servants, agents, invitees or licensees the Strata Company shall be entitled to recover the amount so expended as a debt in an action in any Court of competent jurisdiction from the proprietor who was the proprietor of the lot at the time when the breach occurred.

- (c) in accordance with Schedule 2 by-laws 17 and 18 will unanimously resolve to employ a Strata Company Manager for a term of five (5) years commencing from the date of the issue by the local government authority of the certificate of classification for the building.

29. Amendments to Schedule 1 of the by-laws of the Strata Company.

The Strata Company by-laws comprising Schedule 1 may only be amended, repealed or added to by a resolution without dissent of the Strata Company, in accordance with the Act together with the approval of the local government authority and/or the Western Australian Planning Commission, if required.

30. Amendments to Schedule 2 of the by-laws of the Strata Company.

The Strata Company by-laws comprising Schedule 2 may only be amended, repealed or added to by special resolution of the Strata Company, in accordance with the Act together with the approval of the local government authority and/or the Western Australian Planning Commission, if required.

**STRATA COMPANY BY-LAWS
SCHEDULE 2**

1. Use of lots.

No lot is to be used for any purpose that contravenes any by-law of the Strata Company or requirement or by-law of the local government authority and any other authority that may have jurisdiction over the use to which a lot may be put and within the scheme certain lots are permitted to be used for commercial purposes as well as residential.

2. Behaviour of proprietors, occupiers and tenants within the scheme.

A proprietor, occupier or tenant of a lot shall not:-

- (a) use any lot or part of the common property for any purpose which may be a breach of any Strata Company by-law applying to the scheme, any local government authority regulation or by-law, or any other government and regulating authority law;
- (b) use the lot that he or she owns, occupies, leases or rents for any purpose that may be illegal or injurious to the reputation of the scheme;
- (c) use any part of the common property for any purpose which may be unclean;
- (d) obstruct lawful use of common property by any person or permit to be done anything whereby any obstruction, restriction or hindrance may be caused to the entrances, exits, access roads, pathways, of any lot or any part of the common property to any person lawfully using the same;
- (e) park or stand any motor or other vehicle upon common property, except with the approval of the Strata Company, other than in areas set aside for such use and allocated to that proprietor;
- (f) use any part of the common property for the parking or standing of a caravan, camper van, trailer, marine craft or commercial vehicle other than within those areas set aside for such use as may be allocated from time to time by the Strata Company;
- (g) park or leave any vehicle in such a position where it is likely to be a nuisance or obstruct access or egress to any car parking area, strata lot, any part of the common property or any part of the scheme;
- (h) use any facility or utility situated within common property for any purpose other than that for which it is specifically intended;
- (i) deposit or throw upon the common property any rubbish, dirt, dust or other material likely to interfere with the peaceful enjoyment of the proprietor, occupier or tenant of another lot or of any person lawfully using the common property;

- (b) The initial strata plan, Stage 1, will be created upon the completion of construction of the building shown on the strata plan and will comprise of 6 vacant building strata lots numbered 1 to 6, inclusively, which will be suitable for the construction in accordance with the plans and specifications and a cubic space strata lot numbered 7, the Development Lot, suitable for the further construction of the remainder of the buildings in accordance with the plans and specifications, in accordance with the proposed strata plan contained in the Schedule hereto and marked "Stage One".
- (c) The further construction of the building will be undertaken in the following Stages:
 - (i) Stage 2 will comprise of the completion of the construction of the first floor slab within the Development Lot and the re-subdivision of the Development Lot, being lot 7, to create a further 9 vacant building strata lots numbered 8 to 16, inclusively, suitable for the further construction of the remainder of the buildings in accordance with the plans and specifications, in accordance with the proposed strata plan of re-subdivision contained in the Schedule hereto and marked "Stage Two".
 - (ii) Stage 3, the final Stage, will comprise of the completion of the construction of the building, being all of the internal and external walls in accordance with the construction plans and specifications and upon the completion of such construction the strata plan then comprising of lots 1 to 6 and lots 8 to 16 will be re-subdivided and upon this final re-subdivision of the strata plan all the lots comprising the strata plan will be numbered 17 to 31, inclusively, in accordance with the proposed strata plan of re-subdivision contained in the Schedule hereto and marked "Stage Three".
- (d) All of the strata lots created by the strata plan will be serviced by sewer, water, power and gas and will be suitable for the construction of the building works as detailed in the construction plans and specifications for the Development.
- (e) The development or redevelopment of the strata lots must comply with an existing development approval issued by the local government authority or such alternative development approval as the local government authority may grant, which complies with the development requirements of the local government authority's Town Planning Scheme and planning policies; and
- (f) amendment to or repeal of the above provision cannot be effected without the Western Australian Planning Commission agreement.

27. Re-subdivision of the strata plan.

- (a) When the construction of each Stage is completed, as detailed in by-law 26, the strata plan will be re-subdivided, specifically the Development Lot, to create the further strata lots as detailed in by-law 26, in accordance with the strata plans of re-subdivision for each Stage contained in the Schedule hereto; and
- (b) the unit entitlement for the strata scheme will be reallocated in accordance with the proposed schedules of unit entitlement upon each re-subdivision of the strata plan contained in the Schedule hereto.
- (c) The re-subdivision of the strata plan to be in accordance with sections 8, 8A (a) (ii) II and item 8 of Schedule 2A and sections 8B and 8C of the Strata Titles Act 1985, as amended.

28. Proposed unanimous resolutions of the Strata Company to be passed at the First Annual General Meeting of the Strata Company.

- (a) In accordance with section 7 of the Act the Strata Company will unanimously resolve to approve the proposed construction referred to in Schedule 1 by-law 26 of the Management Statement; and
- (b) in accordance with sections 8 and 8A of the Act the Strata Company will unanimously resolve to approve the re-subdivision of the strata plan in accordance with Schedule 1 by-laws 26 and 27; and

21. Air conditioning operating costs.

The costs of maintenance, operation, insurance, repair and replacement of the individual air conditioning plants contained within the building shall be the responsibility of the registered proprietor of the strata lot to which the air conditioning plant relates and any costs of any damage repairs or replacements to any part of the common property that may become necessary, due to the repair, maintenance or replacement of any air conditioning plant for which a registered proprietor is responsible shall be the responsibility of that registered proprietor.

22. Installation of machinery.

No proprietor or occupier will install any machinery within any lot within the strata scheme, so that part of that machinery projects into common property without obtaining approval for such installation from the Council of the Strata Company, such approval to be given in writing by the Council of Strata Company prior to any installation taking place.

23. Exclusive use rights over common property relative to air conditioning & any machinery installation.

In accordance with section 42(8) of the Act the rights of exclusive use and enjoyment are granted, over that volume of common property occupied by any air conditioning plant and any machinery, to an individual strata lot within the strata scheme, to the registered proprietor of the strata lot to which the air conditioning plant or machinery relates;

and further-

any costs of any damage repairs or replacements to any part of the common property that may become necessary, due to the repair, maintenance or replacement of any air conditioning plant or machinery for which a registered proprietor is responsible shall be the responsibility of that registered proprietor.

24. Access to common property for maintenance of air conditioning & any machinery installation.

A lot proprietor shall have access to the areas of common property external to the strata lots contained within the strata scheme, at all times, subject to the by-Laws for the maintenance, repair or replacement of any machinery or building repair that may be required in respect to any air conditioning plant or machinery installation that is the responsibility of a registered proprietor, provided that the registered proprietor has first given reasonable notice to that effect, verbally or in writing, to the Council of the Strata Company that such access is required.

25. Strata Company to be advised of defects to services.

A proprietor shall give the Strata Company prompt notice of any accident to or defect in the supply of sewer, water supply, gas, electricity, telephone and any other service situated within the common property which comes to his or her knowledge and the Strata Company shall have authority to enter upon any lot, by its agents or servants, if necessary in the circumstances, having regard to the urgency involved, to carry out such repairs or renovations as may deem necessary.

26. Development of the strata scheme.

The strata scheme is to be developed in accordance with the construction plans and specifications approved by the local government authority as are contained in the Schedule hereto on the following basis:

- (a) The strata scheme is to be created by the progressive construction of the building within the parcel in accordance with the plans and specifications, the progressive construction is referred to as "Stages".

- (2) The common seal of the Strata Company will only be used in the presence of at least 2 members of the Council, who shall sign every instrument, document or certificate of the Strata Company to which the seal is affixed, or where there is only one member of the Strata Company that sole signatory shall be sufficient for the purpose of this by-law; and
- (3) where the Strata Company has duly appointed a Strata Company Manager that has also been appointed as agent for the Strata Company and the Strata Company has by resolution authorised the Strata Company Manager to affix the seal then the signature of the Strata Company Manager shall be sufficient for the purpose of this by-law.
- (4) The Council shall make provision for the safe custody of the common seal.

16. Reserve fund.

The Strata Company will at all times administer a reserve fund, in accordance with section 36 (2) of the Strata Titles Act 1985, as amended, for the purpose of accumulating funds to meet contingent expenses, other than those of a routine nature, and other major expenses of the Strata Company likely to arise in the future.

17. Strata Company insurance.

The Strata Company will at all times ensure that an insurance policy in accordance with the Act is in the name of the Strata Company and is current together with any other insurance policy which the Strata Company may decide to be necessary from time to time.

18. Maintenance of common services.

Where any services such as sewer, water supply, gas, electricity and telephone supply and any other service are provided to the scheme and such service or supply is shared in common by all lots:

- (a) the cost of any maintenance, repair or replacement of such service or supply will be the responsibility of the Strata Company; and
- (b) any costs of any maintenance, repair or replacement of such service or supply will be divided between all lot proprietors and will be payable by the individual lot proprietor in the proportion that the individual unit entitlement of each lot bears to the aggregate unit entitlement of the scheme.

19. Maintenance of common services within a lot.

While it is the responsibility of the registered proprietors of the individual lots to maintain all buildings and services contained within the boundaries of the individual lot to which they relate this responsibility will not apply to any common services that may be contained within the boundaries of the lot that are subject to section 11 of the Act, and in this regard sections 38 and 39 of the shall apply.

20. Installation of air-conditioning.

Excluding any air conditioning plant that may have been installed within any strata lot at the time of the construction of the building any other air conditioning units installed in the individual strata lots will be a maximum of 3 horse power capacity, be of the "split system" type, have a copper outlet pipe properly affixed to drain water to the ground, have the outside unit casing of a colour to be inkeeping with colours of the building and be positioned in such a manner so as not to disturb or annoy other proprietors or occupiers of other lots, as will be approved from time to time by the Strata Company, such approval to be given in writing by the Council of Strata Company prior to any installation taking place.

- (6) Except where otherwise required by or under the Act, resolutions may be passed at a general meeting by a simple majority vote.
- (7) At any general meeting a resolution by the vote of the meeting shall be decided on a show of hands unless a poll is demanded by any proprietor present in person or by proxy.
- (8) Unless a poll be so demanded a declaration by the chairman that a resolution has on the show of hands been carried is conclusive evidence of the fact without proof of the number of proportion of votes recorded in favour of or against such resolution.
- (9) A demand for a poll may be withdrawn.
- (10) A poll if demanded shall be taken in such manner as the chairman thinks fit and the result of the poll shall be deemed to be the resolution of the meeting at which such poll was demanded.
- (11) In the case of equality in the votes whether on a show of hands or on a poll, the question is determined in the negative.

13. Moving motions and nominating members of the Council.

A person is not entitled to move a motion at a general meeting or to nominate a candidate for election as a member of the Council unless the person is entitled to vote on the motion or at the election.

14. Voting rights of proprietors.

- (1) On a show of hands each proprietor has one vote.
- (2) On a poll the proprietors have the same number of votes as the unit entitlement of their respective lots.
- (3) On a show of hands or on a poll votes may be given either personally or by duly appointed proxy.
- (4) An instrument appointing a proxy shall be in writing under the hand of the appointer or his or her attorney and may be either general or for a particular meeting.
- (5) A proxy need not be a proprietor.
- (6) Except in cases where by or under the Act a unanimous resolution is required, no proprietor is entitled to vote at any general meeting unless all contributions payable in respect of his or her lot have been duly paid and any other moneys recoverable under the Act by the Strata Company from him or her at the date of the notice given to proprietors of the meeting have been duly paid before the commencement of the meeting.
- (7) Co-proprietors may vote by proxy jointly appointed by them and in the absence of such a proxy are not entitled to vote on a show of hands, except when the unanimous resolution of proprietors is required by the Act.
- (8) On any poll each co-proprietor is entitled to such part of the vote applicable to a lot as is proportionate to his or her interest in the lot.
- (9) The joint proxy (if any) on a poll has a vote proportionate to the interests in the lot of such of the joint proprietors as do not vote personally or by individual proxy.

15. Common seal of the Strata Company.

- (1) The Council of the Strata Company is authorised to use the common seal of the Strata Company to execute any instrument, document or certificate of the Strata Company that may be required pursuant to a resolution of the Strata Company.

- (d) the keeping of the books of account referred to in section 35 (1) (f) of the Act and the preparation of the statement of accounts referred to in section 35 (1) (g) of the Act.

11. General meetings of the Strata Company.

- (1) General meetings of the Strata Company shall be held once in each year so that not more than 15 months shall elapse between the date of one annual general meeting and that of the next.
- (2) All general meetings other than the annual general meeting shall be called extraordinary general meetings.
- (3) The Council may when ever it thinks fit and shall upon a requisition in writing made by proprietors entitled to a quarter or more of the aggregate unit entitlement of the lots convene an extraordinary general meeting.
- (4) If the Council does not within 21 days after the date of the making of a requisition under this or her by-law proceed to convene an extraordinary general meeting, the requisitionists, or any of them representing more than one-half of the aggregate unit entitlement of all of them, may themselves, in the same manner as nearly as possible as that in which meetings are to be convened by the Council, convene an extraordinary general meeting, but any meeting so convened shall not be held after the expiration of 3 months from the date on which the requisition was made.
- (5) Not less than 14 days' notice of every general meeting specifying the place, the date and the hour of meeting and in case of special business the general nature of that business, shall be given to all proprietors and registered first mortgagees who have notified their interests to the Strata Company, but accidental omission to give the notice to any proprietor or to any registered first mortgagee or non-receipt of the notice by any proprietor or by any registered first mortgagee does not invalidate any proceedings at such meeting.
- (6) If a proprietor gives notice in writing to the secretary of an item of business that the proprietor requires to be included on the agenda for the next general meeting of the Strata Company, the secretary shall include that item on the agenda accordingly and shall give notice of that item as an item of special business in accordance with sub-by-law (5) of this by-law.

12. Proceedings at general meetings of the Strata Company.

- (1) All business shall be deemed special that is transacted at an annual general meeting, with the exception of the consideration of accounts and election of members to the Council, or at an extraordinary general meeting.
- (2) Except as otherwise provided in these by-laws, no business may be transacted at any general meeting unless a quorum of members is present at the time when the meeting proceeds to business.
- (3) One-half of the persons entitled to vote present in person by duly appointed proxy constitutes a quorum.
- (4) If within half an hour from the time appointed for a general meeting a quorum is not present, the meeting, if convened upon the requisition of proprietors, shall be dissolved and in any other case it shall stand adjourned to the same day in the next week at the same place and time and if at the adjourned meeting a quorum is not present within half an hour from the time appointed for the meeting, the persons entitled to vote and present constitute a quorum.
- (4) The chairman, may with the consent of the meeting, adjourn any general meeting from time to time and from place to place but no business may be transacted at an adjourned meeting other than the business left unfinished at the meeting from which the adjournment took place.

- (c) signing the ballot-paper; and
 - (d) returning it to the chairman.
- (7) The chairman, or a person appointed by him or her, shall count the votes recorded on valid ballot-papers in favour of each candidate.
- (8) Subject to rule (9), candidates, being equal in number to the number of the Council determined in accordance with by-law 4 (3), who receive the highest numbers of votes shall be declared elected to the Council.
- (9) Where the number of votes recorded in favour of any candidate is the lowest of the numbers of votes referred to in rule (8) and -
- (a) that number equals the number of votes recorded in favour of any other candidate; and
 - (b) if each of those candidates were to be declared elected the number of persons elected would exceed the number of persons required to be elected, as between those candidates, the election shall be decided by a show of hands of those present and entitled to vote.

6. Election of office bearers of the Council.

- (1) The members of a Council shall, at the first meeting of the Council after they assume office as such members, appoint a chairman, a secretary and a treasurer of the Council.
- (2) A person -
- (a) shall not be appointed to an office referred to in sub-bylaw (1) of this by-law unless he or she is a member of the Council; and
 - (b) may be appointed to one or more of those offices.
- (3) A person appointed to an office referred to in sub-bylaw (1) of this by-law shall hold office until -
- (a) he or she ceases to be a member of the Council;
 - (b) receipt by the Strata Company of notice in writing of his or her resignation from that office; or
 - (c) another person is appointed by the Council to hold that office, whichever first happens.
- (4) The chairman shall preside at all meetings of the Council at which he or she is present and, if he or she is absent from any meeting, the members of the Council present at that meeting shall appoint one of their number to preside at that meeting during the absence of the chairman.

7. Chairman, secretary and treasurer of the Strata Company.

- (1) Subject to sub-bylaw (2), the chairman, secretary and treasurer of the Council are also respectively the chairman, secretary and treasurer of the Strata Company.
- (2) A Strata Company may at a general meeting authorize a person who is not a proprietor to act as the chairman of the Strata Company for the purposes of that meeting.
- (3) A person appointed under sub-bylaw (2) may act until the end of the meeting for which he or she was appointed to act.

- (c) signing the ballot-paper; and
 - (d) returning it to the chairman.
- (7) The chairman, or a person appointed by him or her, shall count the votes recorded on valid ballot-papers in favour of each candidate.
 - (8) Subject to rule (9), candidates, being equal in number to the number of the Council determined in accordance with by-law 4 (3), who receive the highest numbers of votes shall be declared elected to the Council.
 - (9) Where the number of votes recorded in favour of any candidate is the lowest of the numbers of votes referred to in rule (8) and -
 - (a) that number equals the number of votes recorded in favour of any other candidate; and
 - (b) if each of those candidates were to be declared elected the number of persons elected would exceed the number of persons required to be elected, as between those candidates, the election shall be decided by a show of hands of those present and entitled to vote.

6. Election of office bearers of the Council.

- (1) The members of a Council shall, at the first meeting of the Council after they assume office as such members, appoint a chairman, a secretary and a treasurer of the Council.
- (2) A person -
 - (a) shall not be appointed to an office referred to in sub-by-law (1) of this by-law unless he or she is a member of the Council; and
 - (b) may be appointed to one or more of those offices.
- (3) A person appointed to an office referred to in sub-by-law (1) of this by-law shall hold office until -
 - (a) he or she ceases to be a member of the Council;
 - (b) receipt by the Strata Company of notice in writing of his or her resignation from that office; or
 - (c) another person is appointed by the Council to hold that office, whichever first happens.
- (4) The chairman shall preside at all meetings of the Council at which he or she is present and, if he or she is absent from any meeting, the members of the Council present at that meeting shall appoint one of their number to preside at that meeting during the absence of the chairman.

7. Chairman, secretary and treasurer of the Strata Company.

- (1) Subject to sub-by-law (2), the chairman, secretary and treasurer of the Council are also respectively the chairman, secretary and treasurer of the Strata Company.
- (2) A Strata Company may at a general meeting authorize a person who is not a proprietor to act as the chairman of the Strata Company for the purposes of that meeting.
- (3) A person appointed under sub-by-law (2) may act until the end of the meeting for which he or she was appointed to act.

- (10) Any casual vacancy on the Council may be filled by the remaining members of the Council, except that, in a case where a casual vacancy arises because of the removal from office of a member under sub-by-law (8), the Strata Company may resolve that the casual vacancy shall be filled by the Strata Company at a general meeting.
- (11) Except where there is only one proprietor, a quorum of the Council shall be 2 where the Council consists of 3 or 4 members; 3, where it consists of 5 or 6 members; and 4, where it consists of 7 members.
- (12) The continuing members of the Council may act notwithstanding any vacancy in the Council, but so long as the number of members is reduced below the number fixed by these by-laws as the quorum of the Council, the continuing members or member of the Council may act for the purpose of increasing the number of members of the Council or convening a general meeting of the Strata Company, but for no other purpose.
- (13) All acts done in good faith by the Council shall, notwithstanding that it is afterwards discovered that there was some defect in the appointment or continuance in office of any member of the Council, be as valid as if that member had been duly appointed or had duly continued in office.

5. Procedure for the election of the Council.

The procedure for nomination and election of members of a Council shall be in accordance with the following rules -

- (1) The meeting shall determine, in accordance with the requirements of by-law 4 (3), the number of persons of whom the Council shall consist.
- (2) The chairman shall call upon those persons present and entitled to nominate candidates to nominate candidates for election to the Council.
- (3) A nomination is ineffective unless supported by the consent of the nominee to his or her nomination, given -
 - (a) in writing, and furnished to the chairman at the meeting; or
 - (b) orally by a nominee who is present at the meeting.
- (4) When no further nominations are forthcoming, the chairman -
 - (a) where the number of candidates equals the number of members of the Council determined in accordance with the requirements of by-law 4 (3), shall declare those candidates to be elected as members of the Council;
 - (b) where the number of candidates exceeds the number of members of the Council as so determined, shall direct that a ballot be held.
- (5) If a ballot is to be held, the chairman shall -
 - (a) announce the names of the candidates; and
 - (b) cause to be furnished to each person present and entitled to vote a blank paper in respect of each lot in respect of which he or she is entitled to vote for use as a ballot-paper.
- (6) A person who is entitled to vote shall complete a valid ballot paper by -
 - (a) writing thereon the names of candidates, equal in number to the number of members of the Council so that no name is repeated;
 - (b) indicating thereon the number of each lot in respect of which his or her vote is cast and whether he so votes as proprietor or first mortgagee of each such lot or as proxy of the proprietor or first mortgagee;

3. Power to decorate and affix fittings.

A proprietor may, without obtaining the consent of the strata company, paint, wallpaper or otherwise decorate the structure which forms the inner surface of the boundary of his or her lot or affix locking devices, flyscreens, furnishings, furniture, carpets and other similar things to that surface, if and so long as such action does not unreasonably damage the common property.

4. Constitution of the Council of the Strata Company.

- (1) The powers and duties of the Strata Company shall, subject to any restrictions imposed or direction given at a general meeting, be exercised and performed by the Council of the Strata Company and a meeting of the Council at which a quorum is present shall be competent to exercise all or any of the authorities, functions or powers of the Council.
- (2) Until the first annual general meeting of the Strata Company, the proprietors of all the lots shall constitute the Council.
- (3)
 - (a) Where there are not more than 3 proprietors the Council shall consist of all proprietors and where there are more than 3 proprietors the Council shall consist of not less than 3 nor more than 7 proprietors as is determined by the Strata Company; and
 - (b) where the original proprietor remains a proprietor of at least one lot then that original proprietor shall be a member of the Council in respect to the requirements of this by-law and shall not require election to the Council.
- (4) Where there are more than 3 proprietors the members of the Council shall be elected at each annual general meeting of the Strata Company or, if the number of proprietors increases to more than 3, at an extraordinary general meeting convened for the purpose.
- (5) In determining the number of proprietors for the purposes of this by-law, co-proprietors of a lot or more than one lot shall be deemed to be one proprietor and a person who owns more than one lot shall also be deemed to be one proprietor.
- (6) If there are co-proprietors of a lot, one only of the co-proprietors shall be eligible to be, or to be elected to be, a member of the Council and the co-proprietor who is so eligible shall be nominated by his or her co-proprietors, but, if the co-proprietors fail to agree on a nominee, the co-proprietor who owns the largest share of the lot shall be the nominee or if there is no co-proprietor who owns the largest share of the lot, the co-proprietor whose name appears first in the certificate of title for the lot shall be the nominee.
- (7) On an election of members of the Council, a proprietor shall have one vote in respect of each lot owned by him or her.
- (8) Except where the Council consists of all the proprietors, the Strata Company may by special resolution remove any member of the Council before the expiration of his or her term of office.
- (9) A member of the Council vacates his or her office as a member of the Council:-
 - (a) if he or she dies or ceases to be a proprietor or a co-proprietor of a lot;
 - (b) upon receipt by the Strata Company of notice in writing of his or her resignation from the office of member;
 - (c) at the conclusion of an annual general meeting of the Strata Company at which an election of members of the Council takes place and at which he or she is not elected or re-elected;
 - (d) in a case where he or she is a member of the Council by reason of there being not more than 3 proprietors, upon an election of members of the Council (as a result of there being an increase in the number of proprietors to more than 3) at which he or she is not elected;
 - (e) where he or she is removed from office under sub-by-law (8) of this by-law.

- (j) **“services”** means the supply of electricity, gas, water, sewer, drainage, telephone and any other pipe or cable which delivers those things to a lot or the parcel;
- (k) **“the Strata Company”** means a body corporate constituted pursuant to section 32 of the Act which comes into being upon the registration of the strata plan;
- (l) **“the Strata Company Manager”** means the organisation or person appointed by the Strata Company to administer the affairs of the Strata Company in accordance with Schedule 2 by-law 17;
- (m) **“Strata Company Management Agreement”** means the agreement in accordance with Schedule 2 by-law 18;
- (n) **“strata plan”** means the strata plan registered with the Land Titles Office, the subject of the parcel, as is contained in the Schedule hereto;
- (o) **“the scheme”** means the strata plan, the by-laws of the Strata Company and the buildings, facilities and services contained within parcel.

2. Duties of proprietors and occupiers.

- (1) A proprietor shall -
 - (a) forthwith carry out all work that may be ordered by any competent public or local government authority in respect of his or her lot other than such work as may be for the benefit of the building generally and pay all rates, taxes, charges, outgoings and assessments that may be payable in respect of his or her lot;
 - (b) repair and maintain his or her lot, and keep it in a state of good repair, reasonable wear and tear, and damage by fire, storm, tempest or act of God excepted.
- (1a) A proprietor shall -
 - (a) notify the Strata Company forthwith upon any change of ownership, including in the notice an address of the proprietor for service of notices and other documents under this Act; and
 - (b) if required in writing by the Strata Company, notify the Strata Company of any mortgage or other dealing in connection with his or her lot, including in the case of a lease of a lot, the name of the lessee and the term of the lease.
- (2) A proprietor, occupier or tenant of a lot shall -
 - (a) use and enjoy the common property in such a manner as not unreasonably to interfere with the use and enjoyment thereof by other proprietors, occupiers or tenants, or their visitors; and
 - (b) not use the lot or permit it to be used in such manner or for such purpose as causes a nuisance to any occupier of another lot (whether a proprietor or not);
 - (c) take all reasonable steps to ensure that his or her visitors do not behave in a manner likely to interfere with the peaceful enjoyment of the proprietor, occupier or tenant of another lot or of any person lawfully using common property; and
 - (d) take all reasonable steps to ensure that his or her visitors comply with the by-laws of the Strata Company relating to the parking of motor vehicles.

18. Maintenance of common services.
19. Maintenance of common services within a lot.
20. Installation of air conditioning.
21. Air conditioning operating costs.
22. Installation of machinery.
23. Exclusive use rights over common property relative to air conditioning & any machinery installation.
24. Access to common property for maintenance of air conditioning & any machinery installation.
25. Strata Company to be advised of defects to services.
26. Development of the strata scheme.
27. Re-subdivision of the strata plan.
28. Proposed unanimous resolutions of the Strata Company to be passed at the First Annual General Meeting of the Strata Company.
29. Amendments to Schedule 1 of the by-laws of the Strata Company.
30. Amendments to Schedule 2 of the by-laws of the Strata Company.

SCHEDULE 2

1. Use of lots.
2. Behaviour of proprietors, occupiers and tenants within the scheme.
3. Use of common property.
4. Alterations to common property.
5. Damage to common property.
6. Instructing of contractors by proprietors.
7. Costs of making good any damage.
8. Weight loads to floors.
9. Appearance of the lot.
10. Maintenance of services and parts of building contained within a lot.
11. Maintenance and repair of dividing fence or walls.
12. Blockage of drainage pipes.
13. Water leakage to other lots or common property.
14. Vermin, pests and insects.
15. Garbage disposal.
16. Signage erection and installation within the scheme.
17. Employment of the Strata Company Manager.
18. The Strata Company Management Agreement.
19. Variation of the Strata Company Management Agreement.
20. Termination of the Strata Company Management Agreement.

STRATA COMPANY BY-LAWS SCHEDULE 1

1. Interpretation.

- (a) **“the Act”** means the Strata Titles Act 1985, as amended;
- (b) **“the by-laws”** means the by-laws of the Strata Company as are contained in this management statement;
- (c) **“common property”** means all that part of the strata plan that is not a lot or part of a lot on the strata plan;
- (d) **“the Council”** means the Council of the Strata Company;
- (e) **“landscaping”** means the foliage, trees, shrubs, grass and vegetation treatment to areas of the lots and the parcel used to enhance the appearance of the strata scheme;
- (f) **“the local government authority”** means the City of Fremantle;
- (g) **“lot”** means a strata lot contained on the strata plan;
- (h) **“the original proprietor”** means Investment Club Pty Ltd and Kavilla Pty Ltd;
- (i) **“the parcel”** means the land comprised in the strata plan;

FORM 25

Strata Titles Act 1985

Section 5C(1)

STRATA PLAN No. 37612.

MANAGEMENT STATEMENT

(Name of original proprietors of land the subject of the plan):

INVESTMENT CLUB PTY LTD (ACN 078 127 536) and KAVILLA PTY LTD (ACN 078 851 742)

(Description of parcel the subject of the plan) Fremantle Town Lot 441 and being the whole of the land comprised in Certificate of Title Volume 1502 Folio 185 *now Vol 2188 Fol 943*

This management statement lodged or to be lodged with a strata plan in respect of the above land sets out the by-laws of the Strata Company or amendments to the by-laws contained in Schedule 1 and Schedule 2 of the *Strata Titles Act 1985* that are to have effect upon registration of the strata plan.

1. The Schedule 1 by-laws are hereby amended, repealed, and added to as follows:-

the by-laws in Schedule 1 to the Act and numbered 1 to 15, inclusive, as they apply to the scheme referred to in the strata plan are repealed and the by-laws numbered 1 to 30, inclusive, are adopted as the Schedule 1 by-laws of the Strata Company as follows in Schedule 1:-

2. The Schedule 2 by-laws are hereby amended, repealed, and added to as follows:-

the by-laws in Schedule 2 to the Act and numbered 1 to 14, inclusive, as they apply to the scheme referred to in the strata plan are repealed and the by-laws numbered 1 to 20, inclusive, are adopted as the Schedule 2 by-laws of the Strata Company as follows in Schedule 2:-

INDEX OF BY-LAWS

SCHEDULE 1

1. Interpretation.
2. Duties of proprietors and occupiers.
3. Power to decorate and affix fittings.
4. Constitution of the Council of the Strata Company.
5. Procedure for the election of the Council.
6. Election of office bearers of the Council.
7. Chairman, secretary and treasurer of the Strata Company
8. Meeting procedure and powers of the Council.
9. Powers and duties of the secretary of Strata Company
10. Powers and duties of the treasurer of Strata Company
11. General meetings of Strata Company
12. Proceedings at general meetings of the Strata Company
13. Moving motions and nominating members of the Council.
14. Voting rights of proprietors.
15. Common seal of the Strata Company
16. Reserve fund.
17. Strata Company insurance.

1.

MANAGEMENT STATEMENT

SECTION 5C (1)

STRATA TITLES ACT 1985, as amended.

**"PAKENHAM APARTMENTS"
STRATA PLAN No. 37612**

**56 PAKENHAM STREET, FREMANTLE.
WESTERN AUSTRALIA.**

586ms\150899